

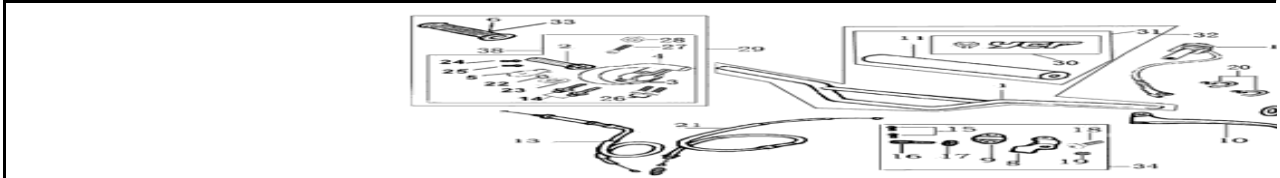

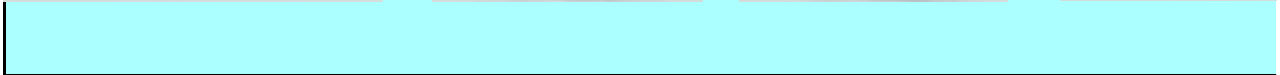

2







BIKE REF FOR ORDERS	19-SM150-STD	BIKE NAME :	SM 15
---------------------	--------------	-------------	-------

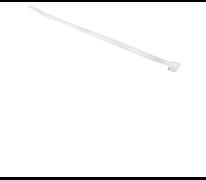
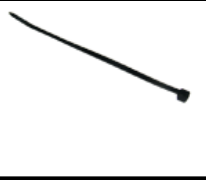
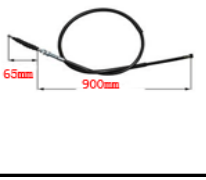

N°	Ref.	Description	Français	Picture
1	YC110-0101-07-BK	Aluminium Handle Bar with bar "LOW" shape L=740mm BLACK	Guidon aluminium avec Barre "BAS" L=740mm NOIR	
	YC110-0140-01	Bar for Aluminium Handle bar	Barre de guidon aluminium	
	YC110-0141-01	Right Clip for Aluminium Handle bar	Maintien barre de guidon droit	
	YC110-0142-01	Left Clip for Aluminium Handle bar	Maintien barre de guidon gauche	

2	YC110-01021-01	YCF Throttle Body 2012 BLACK	plastique poignée de gaz YCF 2012 NOIR	
3	YC110-01021-05	Lower Throttle Body Housing 2014	dessous poignée gaz 2014	
4	YC110-01021-03	Upper Throttle Body Housing YCF 2012	dessus poignée gaz YCF 2012	
5	YC110-01021-02	Upper Throttle Body Housing Cover YCF 2012	plastique du dessus poignée gaz YCF 2012	
6	YC110-01-01-GY	YCF Right Grip GREY	poignée caoutchouc droite YCF GRISE	
7	YC110-01-02-GY	YCF Left Grip GREY	poignée caoutchouc gauche YCF GRISE	
8	YC110-0108-06	Clutch upper bracket 2018 SILVER	cocotte basse embrayage 2018 SILVER	
9	YC110-0109-05	Clutch lower bracket 2014-17 SILVER	Demi cocotte embrayage 2014-17 SILVER	
10	YC110-0110-03	Clutch lever 2018 (with FB13-d8xd10x6-Cu 1EA+FB13-d8xd10x8-Cu 1EA)	levier embrayage 2018	
11	YC110-0116	Bar pad for Aluminium Handlebar with Bar L=195mm	Mousse guidon pour guidon alu avec barre L=195mm	







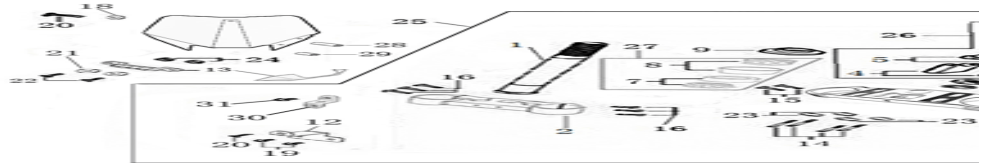

12	YC110-0105-11	Kill Switch ON/OFF Waterproof P125 2019	Coupe circuit on off ETANCHE P125 2019	
13	YC110-0106	Throttle Cable L=840mm A+B=125	Cable gaz L=840mm A+B=125	
	YC110-0143-01	RUBBER ON THROTTLE CABLE		
14	GB5787-M6x22-G	Hex. Bolt with Flanged Face M6X22 for fron brake	vis M6X22 pour frein avant	
15	GB5787-M6x20-G	Hex. Bolt with Flanged Face M6X20 for clutch bracket	vis M6X20 pour cocotte embrayage	
	YC110-0144-01	Aluminium adjust screw for 2018 clutch lever	Molette Reglage aluminium pour Levier embrayage 2018	
	YC110-0150-01	Clutch Adjust bolt for 2018 clutch lever	Tendeur cocotte pour Levier embrayage 2018	
18	27-06025B	Clutch Stepped bolt M6X25	vis cloche embrayage M6X25	
19	6183-06000B	Cltch Self-lock Nut M6	ecrou cloche embrayage M6	
20	YC110-01-03-BK	Tape 150mm BLACK	colier maintien cable 150mm NOIR	











20	YC110-01-03-WH	Tape 150mm WHITE	colier maintien cable 150mm BLANC	
20	YC110-01-05-BK	Tape 350mm BLACK	colier maintien cable 350mm NOIR	
21	YC110-0108	Clutch Cable Assy. L=900mm A+B=65mm	cable embrayage L=900mm A+B=65mm	
22	YC110-0102-08	YCF Throttle cable Bearing d8xd16x5mm	Roulement poignee gas YCF d8xd16x5mm	
23	YC110-0102-07	YCF Throttle cable guide pulley plastic d12xd16xd28x8mm	Roulette plastique Poignee Gas YCF d12xd16xd28x8mm	
24	GB819-M4x12	Plus screw M4x12 for Upper Throttle Body Housing Cover	vis M4x12 plastique du dessus poignée gaz	
25	GB819-M4x20	Plus screw M4x20 for Upper Throttle Body Housing Cover	vis M4x20 plastique du dessus poignée gaz	
26	GB70-M6x25-B	Hex. Bolt M6x25	vis M6x25	
27	GB70-M5x12	Hex. Bolt M5x12	vis M5x12	
30	YC110-0130-05	PVC for Bar Pad suitable Chromolly Handlebar 246mmx156mm 2018 BLACK-WHITE	PVC mousse guidon Chromolly 246mmx156mm 2018NOIR-BLANC	









31	YC110-0131-02	Complete Bar Pad for Chromolly Handlebar L=250mm 2018 BLACK	Mousse guidon complete pour guidon Chromolly L=250mm 2018 NOIR	
32	YC110-0132-02	Chromelly Handle Bar with bar pad and pvc L=780mm BLACK	Guidon chromolly complet avec Mousse et Pvc L=780mm NOIR	
33	PPC010-GY	YCF set of grip GREY	Paire de poignée caoutchouc YCF GRISE	
34	YC110-0134-03	Clutch bracket Assy. 2018 SILVER	Cocotte embrayage complete 2018 SILVER	
35	YC110-0135-01	Cnc adjustable bracket with lever 2018	Cocotte CNC réglage rapide avec levier embrayage 2018	
51	YC110-0151-01	Rubber on clutch lever adjustable screw 2018	Caoutchouc levier embrayage molette réglage2018	
36	YC110-0136-01	Rubber on clutch lever 2018	Caoutchouc levier embrayage 2018	
38	YC110-01022-N	YCF Throttle Assy. 2014 without grip (with YC110-0102-08 1EA)	Poignee gaz réglable YCF 2014 nue	

Steering stem assembly





N°	Ref.	Description	Français	Picture
1	YC110-0201-03	Steering stem 233 mm	tige colonne direction 233 mm	
2	YC110-0202-39-BK	Lower triple clamp 160 mm d48mm 2014 MATT BLACK	té fourche inferieur 160 mm d48mm NOIR MAT	
3	YC110-0201-39-BK	Top Triple Clamp 160mm d45mm 2014 (not adjustable) MATT BLACK	té fourche supérieur 160 mm d45mm (non ajustable) 2014 NOIR MAT	
4	YC110-0203-23	Lower Bar Mount CNC START type, not adjustable d22.2 / height 55 mm BLACK	Pontet guidon inférieur non ajustable type START d22.2 / hauteur 55 mm NOIR	
5	YC110-0202-04	Top Bar Mount CNC d22.2 mm/height 18mm START Type BLACK	pontet guidon supérieur d22.2 mm Type START NOIR	
6	YC110-0212-07WH	Front Number Plate 2014 WHITE	PLAQUE AVANT 2014 BLANC	
7	297-46/23.5	Lower Taper roller bearing 46/23.5	roulement inférieur 46/23.5	
8	297-46/22	Top Taper roller bearing 46/22	roulement supérieur 46/22	
9	YC110-02-09	Top nut for steering d52	écrou crantellé colonne direction d52	

10	YC110-02-10	Washer for steering stem nut d22.5xd36x0.7	joint colonne direction d22.5xd36x0.7	
11	YC110-02-11	Nut for steering stem M22	écrou supérieur colnne direction M22	
13	YC110-0214-01-WH	Break Line Retainer 2014 White (with GB9074.5-M4x10-W 1EA)	guide durite sur plaque avant 2014 Blanc	
14	GB70-M8x30	Stud screw M8X30 for bar mount bottom	vis M8X30 pour dessous pontet	
15	GB70-M6x25	Stud screw M8X25 for bar mount top	vis M8X25 pour dessus pontet	
16	GB70-M6x25	Stud screw M6X25 for clamp top / bottom	vis M6X25 pour te superieur / inferieur	
17	GB70-M8x25	Stud screw M8X25 for top bar mount	vis M8X25 pour pontet superieur	
	GB93-d8-W	Spring washer d8mm for bar mount bottom	Rondelle d8mm pour dessous pontet	
18	GB97-d6-W	flat washer d6 for Number plate bracket	rondelle d6 Support plaque avant	
19	GBT5787-M6x16-3	Hex. Bolt with flanged M6X16 front mudguard (spacer 3 mm)	vis M6X16 garde boue avant (deport 3 mm)	

21	GB97-d4-W	flat washer d4 (for bottom front No plate)	rondelle d4 bas plaque No avant	
22	GB818-M4x10-W	Plus screw M4x10 (for bottom front No plate)	vis M4x10 bas plaque No avant	
25	YC110-02-041-BK	Complete Triple Clamp (TOP45 / BOTTOM 48) START Type 2014 MATT BLACK	Te Fourche Complet (TE SUP. 45 / TE INF.48 Type START 2014 NOIR MAT	
26	YC110-0203-05	Set of Bar mount not adjustable d22.2mm/bottom 55mm START Type BLACK (with GB70-M8x25 4EA+GB70-M8x30 4EA+GB93-d8-W 4EA)	jeu pontet guidon non ajustable d 22.2mm / pontet bas 55mm Type START NOIR	
27	KRDIRECTION46	set of bearing for steering 46/23.5, 46/22	kit rlt colonne direction 46/23.5, 46/22	
30	YC110-0213-08	Number plate bracket 2014	support plaque avant 2014	
31	GB5787-M6x16-W	Hex. Bolt M6X16 for top Number plate bracket	Vis M6x16 Support plaque avant te sup.	
32	YC110-02-20	Washer for steering stem nut	joint colonne direction	

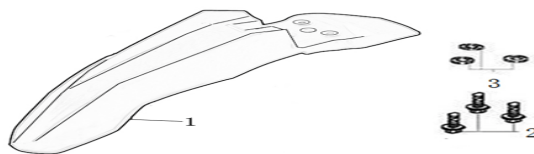



Front Fender



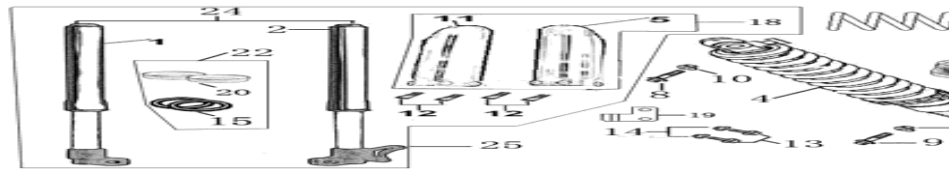













N°	Ref.	Description	Français	Picture
1	YC110-032-01WH	YCF Front Fender 2014 WHITE	GARDE BOUE AVANT 2014 BLANC	
2	GBT5787-M6x16-6	Hex. Bolt with flanged M6X16 (spacer 6mm)	vis M6X16 (deport 6mm)	

Front & Rear absorber





N°	Ref.	Description	Français	Picture
1	YC110-0401-11	Front right fork 735mm (not adjustable) GREY	Tube fourche droit 735mm GRIS	
1	YC110-0402-20	Front left fork 735mm (not adjustable) GREY 2016	Tube fourche gauche 735mm GRIS 2016	
4	YC110-0404-17	Shock absorber PILOT 310mmx800lbs YELLOW	Amortisseur PILOT 310mmx800lbs JAUNE	
4	YC110-0422-02	Stick for Shock absorber L=232mm	Tube Acier mou maintient moto dans caisse L=232mm	





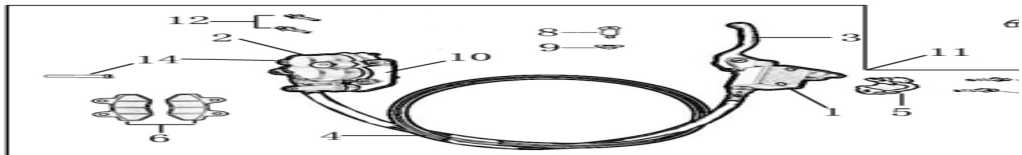





5	YC110-04-015-WH	YCF Left front fork protection 735 mm WHITE	Protection fourche YCF gauche 735 mm BLANC	
8	GB5787-M12x45-W	Hex. Bolt with flanged M12X45	vis M12X45	
9	GB5787-M12x45-W	Hex. Bolt with flanged M12X45	vis M12X45	
10	GB6187-M12-W	Self-locking Nut M12	écrou M12	
11	YC110-04-024	YCF Right front fork protection 735 mm WHITE	Protection fourche droite YCF 735 mm BLANC	
12	GBT5787-M6x14	Screw with flange M6X14 (spacer X mm)	Vis avec epaulement M6X14 (deport X mm)	
16	YC110-0419	shock spacer d12 mm for mono swing arm	entretoise amortisseur d 12 mm mono bas et haut identique	
16	YC110-0417-02	shock top spacer d 12 mm for mono swing arm	Entretoise amortisseur d 12 mm mono bas et haut identique	
18	PFYCF12-WH	Set of fork protection 735 mm YCF 2012 WHITE	Jeu protection fourche 735 mm YCF BLANC	
19	YC110-0403-05	oil steel line retainer on left front fork 2016	passse durite sur protection fourche gauche 2016	



13	GB5787-M6x16-W	Plus screw M6X20 for oil steel line retainer on left front fork 2016-17	Vis M6X20 pour sur protection fourche gauche 2016-17	
14	GB6170-M6-W	Nut M6 for oil steel line retainer on left front fork 2016-17	Ecrou M6 pour sur protection fourche gauche 2016-17	
24	YC110-0400-20	Pair of fork 735mm (not adjustable) GREY 2016	Jeu de fourche 735mm GRIS 2016	
	GB93-d6-W	Standard spring washer d.6	rondelle d.6	
	GB70-M6x30	Hex. Bolt M6x30 for tightening front wheel axle	vis M6x30 pour serrage axe roue avant	

Front Brake Assy





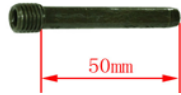



N°	Ref.	Description	Français	Picture
1	YC110-0501-0104	Front Brake Reservoir for 2 pump d10 2016	maitre cylindre frein avant pour étrier 2 pistons d10 2016	
2	YC110-0501-0205	Front Brake caliper for 2 pump w/t abestos	étrier frein avant double pistons sans amiante	

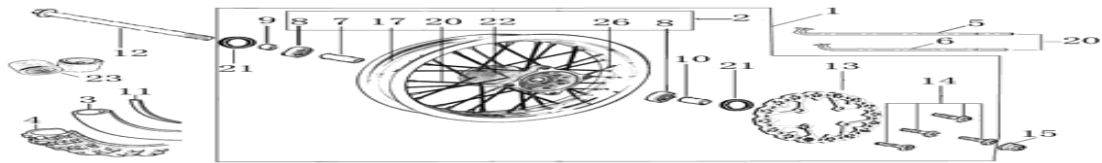







3	YC110-0517-01	Front brake lever for 2 pump brake adjustable 2019	levier frein pour frein double pistons ajustable 2019	
4	YC110-0501-0313	Front brake steel line L=1110mm d10/d10 BLACK 2016	durite frein avant L=1110mm d10/d10 NOIR 2016	
5	YC110-0501-022	Brake perch bracket for double pump	demi cocotte frein avant pour frein double pistons	
6	YC110-0501-0403	Front Brake pads for double pump brake with copper substrate	jeu plaquette frein avant pour frein 2 pistons SANS AMIANTE	
7	GB5787-M6x22-G	Hex.bolt with flanged M6X22 for Brake perch bracket	vis M6X22 pour demi cocotte frein avant	
8	HB06-M6x25-G	Hex.bolt with flanged M6X25 front front brake lever	vis M6X25 pour levier frein avant	
9	GB6177-M6-G	Self-locking nut M6	écrou M6	
10	YC110-0501-030	Bracket for front brake 2 pumps	patte frein avant etrier 2 pistons	
11	YC110-0501-19	front brake assy 2 pumps L=1110mm d10/10 w/t abestos 2016	kit frein avant 2 pistons avec gaine plastic noire L=1110mm d10/10 sans amiante 2016	
12	GB70-M6x30	Stud screw M6X30 for front brake caliper	Vis M6X30 pour etrier frein avant	



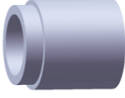

14	YC110-0555	caliper screw for front brake L=50mm Army green	vis plaquette frein avant L=50mm	
15	YC110-0515-01	rubber for brake lever	caoutchouc levier frein avant	

Front Wheel Assy





N°	Ref.	Description	Français	Picture
1	YC110-0601-27	Complete STEEL Front wheel 1.85x12' with disk. Casting hub	roue avant complète ACIER 1.85x12' moyeux injecte avec disque	
2	YC110-0602-21	Complete STEEL Front wheel 1.85x12' without disk. Casting hub	roue avant complète ACIER 1.85x12' moyeux injecte sans disque	
3	CHAMBRE12	Tube for front tire 3.00-12 GL	chambre air 12' standard GL	
	FB6170-M8-Cr	Tire valve nut M8	Ecrou M8 pour Chambre a air	
4	100/90-12	YCF Front tyre 100/90/12	YCF pneu 100/90/12	

7	YC110-0601-02	Front axle bushing d16xd22x44	entretoise central roue avant d16xd22x44	
8	96140-6202-2Z	Ball bearing 6202-2Z d35xd15x11	roulement roue 6202-2Z d35xd15x11	
9	YC110-06-047	Front wheel spacer right d15xd22x23mm with STEP 2015	entretoise roue avant droite d15xd22x23mm	
10	YC110-06-052	Front wheel spacer left d15xd22x33mm	entretoise roue avant gauche d15xd22x33mm	
11	YC110-11-01	tire lining 12"	fond jante 12'	
12	YC110-06-062	Front Axle L=215 mm with holes with Self-locking nut M14 for SM bikes	axe de roue avant L=215mm perces avec ecrou M14 pour supermoto	
13	YC110-0513-02	Front disk d220 mm 2016	disque frein avant d220 mm 2016	
14	GB70.2-M8x16	Screw for disk M8X16 for front disk	vis disque frein M8X16 pour disque avant	
15	GB6187-M14-W	Self-locking nut M14 for front wheel axle	Ecrou roue avant M14 pour axe roue avant	
17	YC110-0617-21	STEEL Rim for Front wheel 1.85x12	cerceau roue av1.85x12' ACIER	



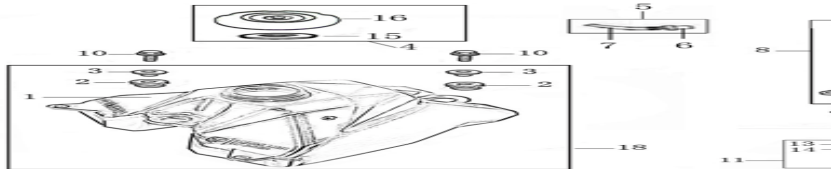

20	JR12-12.5	set of front spoke 12' (120mmx16+122mmx16) 10K (3.2mm)	Jeu rayon avant 12' (120mmx16+122mmx16) 10K (3.2mm)	
21	YC110-0611	OIL SEAL d22x35x5	joint spy roue d22x35x5	
22	YC110-0622-02	Front hub casting with oil seal	moyeux avant injectée avec joint spy	
23	YC110-30	Teflon SM	Tampon teflon pour axe avant / arriere SM	
	GB5787-M6x25-W	Hex. Bolt with Flanged M6X25	vis M6x25	

Fuel Tank





N°	Ref.	Description	Français	Picture
1	YC110-0701-01	YCF Fuel tank with YC110-1910 1EA (suitable for pre 2013 bikes)	Reservoir YCF (Adaptable pour motos avant 2013)	
2	YC110-07-01	Cushion for fuel tank	caoutchouc pour reservoir	

3	YC110-07-02	Washer for fuel tank d12xd30x11mm	entretoise pour reservoir d12xd30x11mm	
4	YC110-0702-01	YCF Tank cap plastic 2013	Bouchon reservoir plastique YCF 2013	
5	YC125-0704-BK	Fuel tank valve BLACK	Valve prise air NOIR	
6	YC110-0704-BK	Cap of Fuel tank valve BLACK	Capuchon Valve prise air NOIR	
7	YC110-0705-BK	Fuel tank valve Hose L=40mm BLACK	Durite caoutchouc Vale prise air L=40mm NOIRE	
8	YC110-0703	Fuel cock assy.	robinet essence	
9	GB5787-M6x16-W	Plus screw M6X12 for fuel cock	vis M6X12 pour robinet essence	
10	GB5787-M8x25-B	screw M8X25 BLACK for gas tank	vis M8x25 NOIR pour reservoir	
10	GB5787-M8x30-B	screw M8X30 BLACK for gas tank	vis M8x30 NOIR pour reservoir	
11	YC110-0706	fuel tank rubber line + spring d4.5xd8.5x210mm	durite reservoir avec ressort d4.5xd8.5x210mm	

12	YC110-07061	fuel tank Ispring L=180mm	ressort durite reservoir L=180mm	
13	YC110-07062	fuel tank rubber line d4.5xd8.5x210	durite reservoir d4.5xd8.5x210	
14	YC110-07063	Holding ring	collier FILTRE	
15	YC110-0720-02	Rubber mat for tank cap plastic d14xd52x2mm Oil proof	Caoutchouc bouchon reservoir YCF d14xd52x2mm	
17	YC110-0717	O-RING,d11x3mm For Fuel tank	Joint Thorique d11x3mm pour Reservoir	
18	YC110-0718	YCF Complete fuel tank suitable for pre 2013 bikes (with YC110-07-01 2EA+YC110-07-02 2EA+YC110-1910 1EA)	Reservoir complet YCF 2013 (Adaptable pour motos avant 2013)	

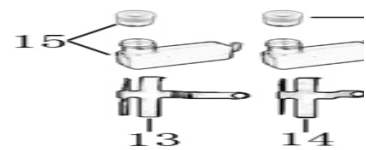
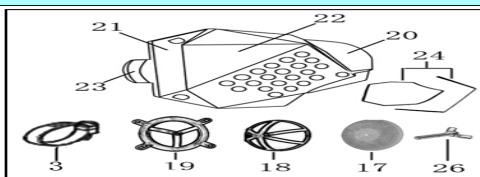





Air Filter





N°	Ref.	Description	Français	Picture
1	YC110-0801-07	Air box assy Pilot 2015	Boite a air complete Pilot 2015	







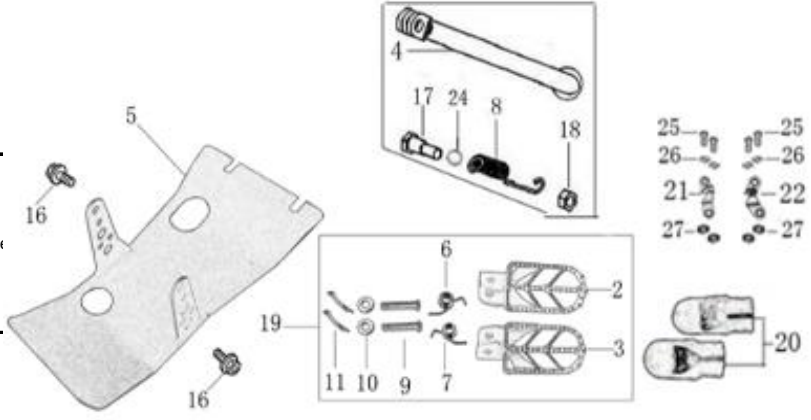



3	YC110-0805	Holding ring d27-d51mm	collier Filtre d27-d51mm	
17	YC110-0817-03	YCF Air filter Foam 2018 DOUBLE THICKNESS	Mousse filtre a air YCF 2018 DOUBLE EPAISSEUR	
18	YC110-08-012	Top support for YCF air filter foam	support exterieur pour mousse filtre a air YCF	
19	YC110-08-013	Inside support for YCF air filter foam	support interieur pour mousse filtre a air YCF	
	GB70.2-M5x12	Plus screw M5X12	vis M5X12support interieur pour 4	
26	GB62-M6x30-W	Butterfly screw M6x30	vis M6x30	
20	YC110-0820-02	Rear part of Pilot 2015 air box	Boitie arriere boite a air Pilot 2015	
	YC110-0825-01	support of Air box PILOT 2015	Support Boit a Air Pilot	
	GB70.2-M6x16	Plus screw M6X16 for air box support	vis M6X16 pour Support Boite a air	
	GB6189-M6-W	Cltch Self-lock Nut M6 for air box support	ecrou M6 pour Support Boite a air	

21	YC110-0821-02	Front case of Pilot 2015 air box	Boitie avant boite a air Pilot 2015	
	GB70-M4x20	Hex. Bolt M4x20	vis M4x20 Couvercle cote boite 2	
22	YC110-0822-02	Cover with logo of Pilot 2015 air box	Couvercle cote boite a air YCF avec logo Pilot 2015	
	GB70-M4x20	Hex. Bolt M4x20	vis M4x20 Couvercle cote boite 2	
23	YC110-08-0174	Rubber link between air box and carb for PILOT 2016 air box d40mm	manchon boite a air PILOT 2016 d 40 mm	
13	YC110-83	The carburetor YouHu stents	PATTE DE RECUPERATEUR ESSENCE	
14	YC110-84	The engine YouHu stents	PATTE DE RECUPERATEUR HUILE	
	GB5787-M6x16-W	screw M6X16 for skid plate	vis sabot M6X16	
14	YC110-86	The engine YouHu stents	PATTE DE RECUPERATEUR HUILE	
	GB5787-M6x12-W	Plus screw M6X12	vis M6X12	

	GB6177-M6-W	Hex. Flanged nut M6	écrou M6	
15	YC110-80	Gas tank	Bac Recuperateur essence	
16	YC110-81	Oil tank	Bac Recuperateur Huile	
	YC110-8001	Caps Oil tank	Bouchon Bac Recuperateur essence / huile	
	YC110-8002	Oil tank	Bac Recuperateur essence / huile	
	YC110-01-03-BK	Tape 150mm BLACK	colier maintien cable 150mm NOIR	

Foot Peg assy





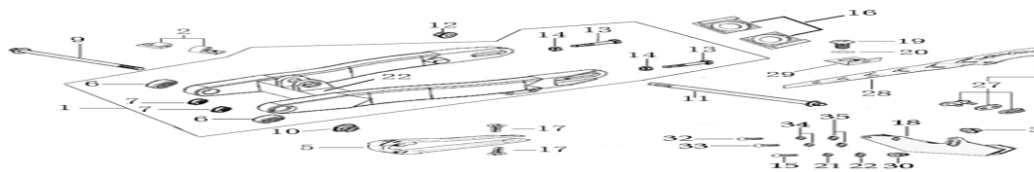

N°	Rt		Picture
2	YC110-0902-		 113 GRIS

3	YC110-0903-01	Left foot peg Steel START / PILOT 2013 GREY	Repose pied Acier gauche START / PILOT 2013 GRIS	
6	YC110-09-01	Spring for right steel foot peg d1.5xd16.5x10mm	ressort repose pied droit acier d1.5xd16.5x10mm	
7	YC110-09-02	Spring for left steel foot peg d1.5xd16.5x10mm	ressort repose pied gauche acier d1.5xd16.5x10mm	
9	GB882-d8x43-W	shaft pin for steel footpegs d8x43	axe repose pied acier d8x43	
10	GB97-d8-W	flat washer d8x16x1	rondelle d8x16x1	
11	GB91-d2x25-W	Cotter pin 2.0x25	goupille 2.0x25	
5	YC110-202-01	YCF Engine skid plate Steel START125 / PILOT /SM150 MATTE BLACK	Sabot moteur Acier YCF START125 / PILOT /SM150 NOIR MAT	
16	GB5787-M6x16-W	screw M6X16 for skid plate	vis sabot M6X16	
4	YC110-196	Kick stand 280mm	bequille 280mm	
17	FB02-M10x1.5x30I	Stepped screw M10X35 for kick stand	vis bequille M10X35	

18	GB6170-M10-G	Hex. Nut M10	ecrou bequille M10	
24	GB93-d10-W	Standard spring washer d10	rondelle d10	
8	YC110-19-01	spring for kick stand d2.5xd15x105	ressort bequille d2.5xd15x105	
19	YC110-0902/09	Steel foot pegs set 2013	jeu repose pied Acier 2013	
20	YC110-32	Pedal sheath around	TAMPON TEFLON REPOSE PIED	
21	YC110-36	outer support of Pedal	PATTE AVANT DE REPOSE PIED	
22	YC110-37	inside stents of Pedal	PATTE ARRIERE DE REPOSE PIED	
25	GB818-M4x16-W	Plus screw M4X16	vis M4X16	
26	GB97-d5-W	flat washer d5	rondelle d5	
27	GB6170-M4-W	Nut M4	ecrou M4	

Swing Arm assy



N°	Ref.	Description	Français	Picture
1	YC110-1001-17	swing arm mono Steel 420mm 2018 d. 15 mm	bras oscillant acier mono Acier 420mm 2018 d. 15 mm	
6	6902	NTN Bearingfor swing arm Ø15	Roulement bras oscillent NTN Ø15	
7	YC110-1001-013	Spacer for swing arm d12xd20x11.5	entretoise d12xd20x11.5	
13	GB5783-M8x40-W	Exterior hex. Bolt M8X40	vis tendeur chaine M8x40	
14	FB6170-M8-W	Hex. Nut M8	ecrou tendeur chaine M8	
16	YC110-11-08	Block axle SILVER	Tendeur chaine SILVER	
5	YC110-10-025	Chain slider YCF Aluminium swing arm 420mm PU	patin chaine YCF long pour Bras oscillent Aluminium YCF 420mm PU	

2	YC110-10-014-BK	Rear brake clip for BLACK	attache durite frein arriere NOIR	
17	GB819-M6x16-W	Plus screw M6X16 for Rear brake clip	vis m6x16 pour Attache durite	
	GB6100-M6-CW	nut M6x25mm for Rear brake clip	Vis M6x25mm pour Attache durite	
9	YC110-1009-01	Swing arm shaft with self lock nut M15 L=240mm	Axe bras oscillant d10 avec ecrou M15 L=240mm	
14	GB6187-M15-W	Self locking nut M15	ecrou bras oscillant M15	
24	FB13-20x13x120	Central spacer steel swing arm PILOT 2013	Entretoise centrale de bras oscillent acier PILOT 2013	
11	YC110-11-076	Rear wheel axle L=215mm with holes and Self locking nut M14 for supermoto	axe roue arriere supermoto percee avec ecrou L=215mm avec ecrou M14	
12	GB6187-M14-W	Self locking nut M14	ecrou axe roue arriere M14	
18	YC110-1004	YCF chain guide assy for High class range BLACK	guide chaine YCF pour haut de gamme NOIR	
15	GB70.2-M5x16	Plus screw M5X16 for chain guide assy	vis M5X16 pour guide chaine	

21	GB93-d5-W	Standard spring washer d5 for chain guide assy	rondelle d5 pour guide chaine	
22	GB97-d5-W	Flat washer d5 for chain guide assy	rondelle d5 pour guide chaine	
30	GB6100-M6-CW	Adj. nut for YCF chain guide d5xd7xd10x13mm	Vis réglage guide chaine YCF d5xd7xd10x13mm	
32	GB70-M6x20	Stud screw M6X20 for chain guide assy	vis M6X20 pour guide chaine	
33	GB70-M6x25	Stud screw M6X25 for chain guide assy	vis M6X25 pour guide chaine	
34	GB93-d6-W	Standard spring washer d6 for chain guide assy	rondelle d6 pour guide chaine	
35	GB97-d6-W	Flat washer d6 for chain guide assy	rondelle d6 pour guide chaine	
36	GB6177-M6-W	Hex. Nut M6 for chain guide assy	ecrou tendeur chaine M6 pour guide chaine	
29	YC110-0600-02	Chain box protection support	Support Protection chaine plastique	
29	YC110-0600-021	Chain box protection support	Support Protection chaine plastique	





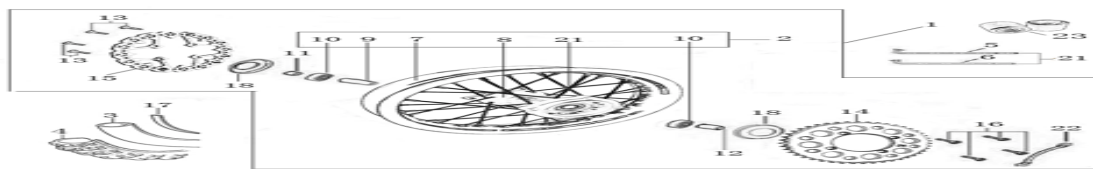



19	GB818-M6x12-W	Plus screw M6x12	vis M6x12	
20	GB97-d6	Flat washer d6	rondelle d6	
26	420H-110T	Chain 420H-110T, normal	chaîne 420 110 maillons standart	
27	AR-420	Chain link	Attache rapide chaîne	
28	YC110-1028-02	Chain box protection	Protection chaîne plastique	
	GB9074.5-M6x12-W	Plus screw M6X12 (for bottom front No plate) for chain protection 2019	vis m6x12bas plaque No avant pour protection chaîne 2019	
	GB6189-M6-W	Hex. Flanged nut M6 for chain protection 2019	écrou M6 pour protection chaîne 2019	

Rear Wheel Assy









N°	Ref.	Description	Français	Picture
----	------	-------------	----------	---------

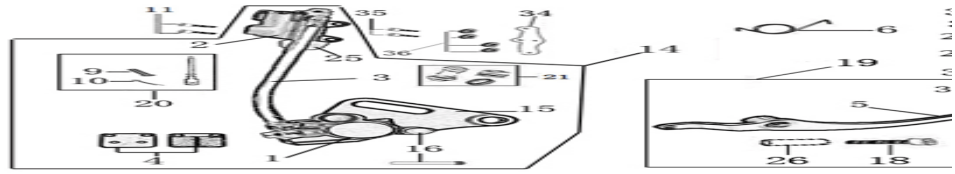









1	YC110-1101-33	Complete STEEL Rear wheel 2.15x12' with disk. Casting hub	roue arriere complète ACIER 2.15x12' moyeux injecte avec disque	
2	YC110-1102-31	Complete STEEL Rear wheel 2.15x12' without disk. Casting hub	roue arriere complète ACIER 2.15x12' moyeux injecte sans disque	
3	CHAMBRE12	Tube for Rear tire 3.00-12' GL	chambre air 12' standard GL	
	FB6170-M8-Cr	Tire valve nut M8	Ecrou M8 pour Chambre a air	
4	120/80-12	YCF Rear tyre 120/80-12	pneu arriere 120/80-12 YCF	
7	YC110-1101-014	STEEL Rim 2.15x12'	cerceau roue 2.15x12' ACIER	
8	YC110-1122-02	Rear wheel hub Casting with oil seal	moyeux arriere injectée avec joint spy	
10	96140-6202-2Z	Ball bearing 6202-2Z d35xd15x11	roulement roue 6202-2Z d35xd15x11	
11	YC110-11-041	Rear wheel spacer right d15xd22x29mm	entretoise roue arriere droite d15xd22x29mm	
12	YC110-11-052	Rear wheel spacer left d15xd22x38mm	entretoise roue arriere gauche d15xd22x38mm	

14	YC110-11-06/45	YCF Driven sprocket 420-45T	couronne acier 45T YCF	
22	YC110-11-03	Sprocket Locking piece	block couronne	
16	GB5783-M8x25-W	Exterior Hex.Bolt M8X25 for rear sprocket	vis M8x25 pour couronne	
15	YC110-1115-01	Rear Brake disc d200mm 2016	Disque frein arrière d200 mm 2016	
13	GB70.2-M8x16	Screw for disk M8X16	vis disque frein M8X16	
17	YC110-11-01	tire lining 12"	fond jante 12'	
18	YC110-0611	oil seal d23xd35x5	joint spy roue d23xd35x5	
21	JR12-12.6-10K	set of spoke 12' (125mmx24+128mmx8) 10K (3.2mm)	jeu rayon arrière 12' (125mmx24+128mmx8) 10K (3.2mm)	
23	YC110-30	Teflon SM	Tampon teflon pour axe avant / arriere SM	
	GB5787-M6x25-W	Hex. Bolt with Flanged M6X25	vis M6x25	

REAR BRAKE



N°	Ref.	Description	Français	Picture
1	YC110-1201-04	Rear Caliper 1 pistons w/t abestos	étrier frein arrière 1 piston sans amiante	
2	YC110-1201024	Rear reservoir d 10mm (with stick L=45mm)	maitre cylindre frein arrière avec embout durite d 10mm	
3	YC110-1201048	Oil steel tube L=465mm d10/d10 PILOT 2016	durite frein arrière L=465mm d10/d10 PILOT 2016	
4	YC110-1204	Friction pad for 1 piston brake w/t abestos with copper substrate	plaquette frein arrière 1 piston SANS AMIANTE	
5	YC110-1205-06	Steel brake pedal PILOT88s	pédale de frein PILOT88s	
6	YC110-21-01	Spring for Steel brake pedal' d3xd32x7mm	ressort pour pédale de frein Acier d3xd32x7mm	
9	GB882-d7x16-W	Pin shaft 7x16mm for push rod	axe 7x16mm pour fixation tige	







10	GB91-d1.6x16-W	Split pin 1.6x16mm for push rod	goupille 1.6x16mm pour fixation tige	
11	GB70-M6x20	Hex. Bolt M6x20 for rear reservoir	vis M6x20 pour maitre cylindre arriere	
14	YC110-12012-24	Rear brake aasy 1 piston W/T ABESTOS d10/d10 L=465mm 2016	Kit frein arriere 1 piston avec gaine plastic SANS AMIANTE d10/d10 L=465mm 2016	
15	YC110-1201-01	Rear brake bracket T=5MM	patte fixation étrier frein arriere T=5MM	
16	YC110-1255	Rear Brake pads Screw L=38mm	Vis plaquette AR L=38mm	
18	GB70.1-M10x35-B	Nut for brake pedal M10X35	vis pour pédale frein M10X35	
19	YC110-217-01	Steel brake pedal PILOT / SM150 2013	Pédale de frein Acier PILOT / SM150 2013	
21	YC110-120110	rubber for rear caliper	jeu de caoutgouc d'etrier frein arriere	
23	YC110-21-10	Steel brake pedal end cap	embout pédale de frein Acier	
25	YC110-12025-01	Rubber for REAR RESERVOIR PUSH STICK 2016	Caoutchouc tige maitre cylindre frein arrier 2016	

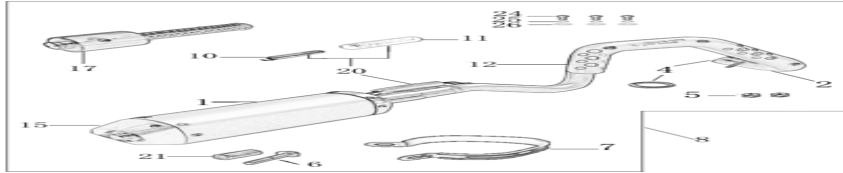









26	FB13-10x14x17-CW	bushing d10xd14x17mm	entretoise d10xd14x17mm	
28	YC110-35	frubber ixing steel plate for brake pedal	plaque support tampon teflon pédale de frein	
29	YC110-31	rubber for brake pedal	tampon téflon pédale frein	
30	GB70-M6x16-Cr	Hex. Bolt M6x16	vis M6x16	
31	GB818-M6x16-W	Plus screw M6X16	vis M6X16	
32	GB97-d6-W	flat washer d6	rondelle d6	
33	GB6170-M6-W	Nut M8	ecrou M8	
34	YC110-1215-06	Mount for rear break reservoir "extern" 2017	fixation maitre cylindre frein arriere "externe" 2017	
35	GB70-M6x16	Hex. Bolt M6x16 for Mount for rear break reservoir	vis M6x16 pour fixation maitre cylindre frein arriere	
	GB97-d6-W	Standard spring washer d6 for Mount for rear break reservoir	rondelle d6 pour fixation maitre cylindre frein arriere	

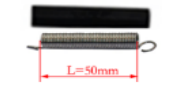

36	GB93-d6	Standard spring washer d5	rondelle d5	
----	---------	---------------------------	-------------	---

Exhaust system







N°	Ref.	Description	Français	Picture
1	YC110-13016-GY	YCF Muffler 94db START L=295mm (1 springs) 2015 GREY	silencieux YCF 94db 2015 GRISE	
2	YC110-1302-10	Exhaust pipe with protection plate d28 mm PILOT 2015	collecteur avec plaque d28 mm PILOT 2015	
4	18291/152FMH	Exhaust pipe washer d32xd25.5x4	joint pot d32xd25.5x4	
5	GB6170-M6-W	Hex flanged self locking nut M6	écrou M6	
	FB13-10x14x23-W	Muffler Hoop spacer d10xd14x23mm	Entretoise attache silencieux d10xd14x23mm	
6	GB5787-M8x40-W	Hex. Bolt with flanged M8x40	vis M8x40	



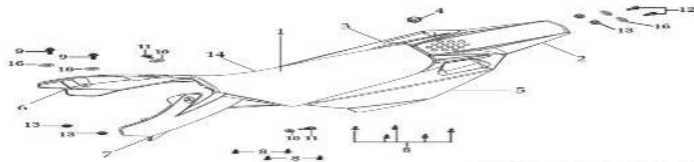







7	YC110-13-04	Hoop for muffler YCF START 2011(with FB13-d10xd14x23-W 1EA+GB5787-M8x40-W 1EA)	Attache silencieux YCF START 2011	
8	YC110-136-03-GY	PILOT / SM150 Muffler& Exhaust pipe assy YCF 94db (1 spring)	Echappement complet YCF 94db PILOT / SM150 (1 ressort)	
10	YC110-13-201	muffler spring d6.5xd9x50mm	ressort pot d6.5xd9x50mm	
11	YC110-138	rubber for muffler spring	caoutchouc ressort pot	
20	YC110-13-21	muffler spring with rubber	ressort pot avec le caoutchouc	
12	YC110-1312-02	Protection for exhaust pipe PILOT / SM150 2013	Grille pot PILOT / SM150	
24	GB70.2-M6x10-Cr	Plus screw M6x10 for exhaust protection	vis M6x10 pour grille	
25	GB93-d6-W	Standard spring washer d6 for exhaust protection	rondelle d6 pour grille	
26	GB97-d6-W	flat washer d6 for exhaust protection	rondelle d6 pour grille	
17	YC110-13-301	Noise reducer (spark arrestor) YCF START	Bride de pot YCF START	

15	YC110-13-32	Muffler end cap YCF	Emout silencieux YCF	
	GB70.2-M5x12-Cr	Plus screw M5x12for muffler end cap	vis M5x12 pour Emout silencieux	
	GB93-d5	Standard spring washer d.5 for muffler end cap	rondelle d5 pour Emout silencieux	



Seat & Plastic kit



N°	Ref.	Description	Français	Picture
1	YC110-1401-17	YCF Seat assy L=510mm 2018	Sells SP 2018	
2	YC110-14-018WH	YCF Rear fender 2016 WHITE with YC110-1404-01 2EA	Garde boue arrière YCF 2016 avec Picots BLANC	
3	YC110-14-028WH	YCF right side plastic assy 2016 WHITE	Plaque latérale droite YCF 2016 BLANC	
17	YC110-1428-01BK	YCF Handle for right side plastic 2016 BLACK	Paire de Poignées Droite pour Plaque Laterales YCF 2016	



19	YC110-1419-01-WH	YCF right side plastic 2016 WHITE	Plaque latérale droite YCF 2016 BLANC	
5	YC110-14-048WH	YCF left side plastic assy 2016 WHITE	Plaque laterale gauche YCF 2016 BLANC	
18	YC110-1429-01BK	YCF Handle for left side plastic 2016 BLACK	Paire de Poignees Gauche pour Plaque Laterales YCF 2016	
20	YC110-1420-01-WH	YCF left side plastic 2016 WHITE	Plaque laterale gauche YCF 2016 BLANC	
	GB819-M5x10-W	Plus screw M5x10	vis M5x10	
21	YC110-1404-01	Cushion for side plastic d8.2d20.2x9mm 2016	caoutchouc plaque laterale d8.2d20.2x9mm 2016	
4	YC110-14-03	Cushion for right side plastic	caoutchouc plaque laterale droite	
23	GB70-M6x12	Hex. Bolt M6x12	vis M6x12	
25	GB97-d6-W	flat washer d6	rondelle d6	
10	YC110-02-13	Rubber washer d6xd14x3mm	joint caoutchouc d6xd14x3mm	



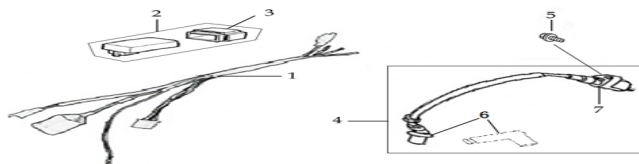

6	YC110-14-059-WH	Right shroud SP1/SP2/SP3 2019 WHITE	ouie radiateur droite SP1/SP2/SP3 2019 BLANCHE	
7	YC110-14-069-WH	Left side shroud SP1/SP2/SP3 2019 WHITE	ouie radiateur gauche SP1/SP2/SP3 2019 BLANCHE	
	GB819-M4x12	Plus screw M4x12	vis M4x12	
8	GB845-ST4.8x16-G	Screw for plastic kit ST4.8x16for seat and plastics fixation	vis plastique ST4.8x16 pour fixation selle sur plastiques	
8	GB845-ST4.8x20-G	Screw for plastic kit ST4.8x20 for seat and plastics fixation	vis plastique ST4.8x20 pour fixation selle sur plastiques	
9	GB5787-M6x20-W	hex. Bolt with flanged M6x20 for shroud fixation on gas tank front	vis M6x20 pour fixation ouis sur reservoir avant	
10	YC110-02-13	Rubber washer d6xd14x3mm	joint caoutchouc d6xd14x3mm pour fixation ouis sur reservoir avant	
11	FB5787-M5x12-W	hex. Bolt with flanged M5x12 for shroud fixation on gas tank sides	vis M5x12 pour fixation ouis sur reservoir cotes	
11	GB96-d5-W	flat washer d5xd12	rondelle d5xd12	
12	GB5787-M6x20-B	hex. Bolt with flanged M6x20 BLACK for seat fixation on subframe	vis M6x20 NOIR pour fixation selle sur boucle acier	

13	GB6177-M6-W	Hex. Flanged nut M6 for shroud fixation on gas tank front	écrou M6 pour fixation ouis sur reservoir avant	
14	YC110-1414-02	YCF seat cover 2018	Housse selle YCF 2018	
16	YC110-03-01	Rubber washer d6xd18x4mm	joint caoutchouc d6xd18x4mm pour fixation ouis sur reservoir avant	
16	GB96-d6	flat washer d6 for shroud fixation on gas tank front	rondelle d6 pour fixation ouis sur reservoir avant	

ELECTRIC









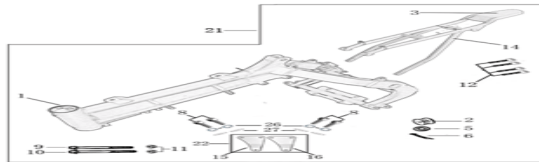



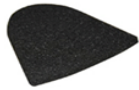

N°	Ref.	Description	Français	Picture
1	YC110-1501-11	Wire harness Waterproof P125 2019	Faisceaux électrique ETANCHE P125 2019	
2	YC110-1503	CDI Ignitor assy.125cc	CDI 125cc	
3	YC110-1501-03	Ignitor rubber	caoutchouc cdi	









4	YC110-1504-07	Ignitor coil L=350mm	bobine haute tension L=350mm	
5	GB5787-M6x20	Hex. Bolt M6x20 for Ignitor coil fixation	vis m6x20 pour fixation bobine haute tension	
6	YC110-1505	anti interference red	anti parasite rouge	
7	YC110-1504	Ignitor coil	bobine haute tension	
22	GB5787-M6x16-W	Hex. Bolt M6x16 for Ignitor coil stents fixation	vis m6x16 pour fixation support bobine	

Frame



N°	Ref.	Description	Français	Picture
1	YC110-1601-05-WH	PILOT F150 / SM150 Chromely Frame (for fork 735mm) 2018 WHITE swing arm axle 15 mm	Cadre chromolly PILOT F150 / SM150 (pour fourche 735mm) 2018 BLANC axe bras d.15 mm	
2	YC110-2201	YCF Chain tensioner component	roulette chaine YCF	

3	YC110-0700-11	Tail cover sponge	Mousse Boucle arriere	
5	GB97-d10-W	Flat washer d10x17x2 for Chain tensioner	rondelle d10x17x2 pour roulette chaine	
6	GB91-d2x25-W	cotter pin d2.0x25 for Chain tensioner	goupille d2.0x25 pour roulette chaine	
	GB5787-M8x80-W	Hex. Bolt with flanger face M8x80	vis M8x80	
9	GB5787-M8x110-W	Hex. Bolt with flanger face M8x110	vis m8x110	
9	GB5787-M8x105-W	Hex. Bolt with flanger M8x105	vis M8x105	
10	GB6187-M8-W	Self locking nut M8	ecrou M8	
12	GB70-M8x25	Hex. Bolt with flanger M8x25	vis boucle arriere M8x25	
	GB70-M8x20	Hex. Bolt with flanger M8x20	vis boucle arriere M8x20	
14	YC110-1614-16-BK	STEEL rear frame part P150/SM150 2019 BLACK	Boucle arriere de cadre ACIER P150/SM150 2019 NOIR	

	YC110-1633-01	Rubber plug for Rear frame part BIGY 2019	Embout Caoutchouc YCF boucle arriere Bigy 2017	
	YC110-1404-01	Rubber for Subframe	Caoutchouc pour Boucle Arriere	
15	YC110-1615-02-BK	frame engine pads left PILOT 150/SM150 BLACK 2014	patte de cadre gauche PILOT 150/SM150 2014 NOIRE	
16	YC110-1616-02-BK	frame engine pads right P150/SM150 2014 BLACK	patte de cadre droite PILOT P150/SM150 2014 NOIRE	
21	YC110-1621-03-WH	complète frame PILOT F150 / SM F150 WHITE / Black pads 2018 swing arm axle 15 mm	cadre complet PILOT F150 / SM F150 BLANC / Pattes Noires 2018 axe bras d.15 mm	
22	YC110-1622-02-BK	set of engine pads PILOT 150 /SM150 2014 BLACK	jeu de patte de cadre PILOT 150/ SM150 2014 NOIRE	
26	GB93-d8-W	washer d8	rondelle d8	
27	GB97-d8-W	Flat washer d8	rondelle d8	

FRONT SPROCKET PROTECTION

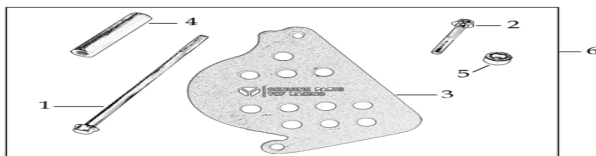





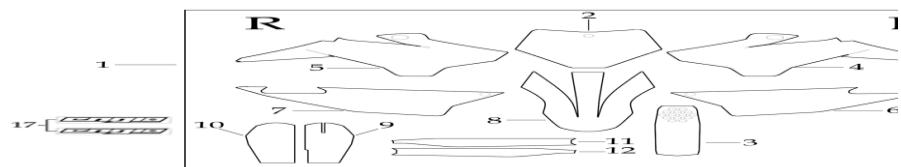

N°	Ref.	Description	Français	Picture
1	GB5787-M6x120-Cr	Hex. Bolt with flanger M6x120 Chrome	vis M6x120	
2	GB5787-M6x40-Cr	Hex. Bolt with flanger M6x40 Chrome	vis M6x40	
3	YC110-24-074-BK	Aluminium chain protection 2013 PILOT / FACTORY BLACK	Protection PSB Aluminium 2013 PILOT / FACTORY NOIR	
4	FB13-7x12x55-W	bushing d7xd12x55	entretoise d7xd12x55	
5	FB13-7x12x7-W	bushing d7xd12x7	entretoise d7xd12x7	
6	YC110-253BK	Complete Aluminium chain protection 2013 PILOT / FACTORY 2013 BLACK	Protection complète PSB Aluminium 2013 PILOT / FACTORY 2013 NOIRE	

GRAPHICS



N°	Ref.	Description	Français	Picture
----	------	-------------	----------	---------

1	KDSM1502019	SM150 complete graphic kit 2019	Kit deco complet SM150 2019	
	YC110-1909	Sticker FACTORY Shock Absorber	Autocollant FACTORY Amortisseur	
	YC110-1910	GAS TANK STICKER	STICKER RESERVOIR	
	YC110-1901	Sticker Chain	Autocollant Chaîne	
	YC110-1902	Sticker Tire	Autocollant Pression Pneu	
	YC110-1903	Sticker Warning OIL Level	Autocollant Attention Niveau Huile	
	YC110-1904	Sticker Rear Mudguard 70x57mm	Autocollant garde boue arriere 70x57mm	
	YC110-1905	Sticker CE	Autocollant CE	
	YC110-1906	Warning sticker	Sticker Attention	
	YC110-1907	Warning Sticker Transport	Sticker Caisse Avertissement Transport	



YC110-1908	Warning Sticker Shosk Absorber	Sticker Avertissement Amortisseur	
------------	--------------------------------	-----------------------------------	---

ENGINES



MOTEUR150-5	ENGINE 150-5 YX	MOTEUR YX DTE150-5	
17311-5	Inlet Pipe,Pro P150 2015	PIPE ADMISSION P150 2015	
GB5787-M6x20-W	Hex. Bolt M6x20 for inlet pipe fixation	vis M6x20 pour fixation pipe admission	
17332	carburettor paper gasket d28	joint papier carburateur d28	
17332/152FMH01	Intake Gasket	JT PAPIER PIPE ADMISSION	
F00C039	carburettor isolating gasket d27.5	joint plastique carburateur d27.5	
11411/152FMH	Crankcase Cover, LH	CARTER ALLUMAGE	
YC140-27600SI	STEEL KICK YCF 2015 BIG HOLE	KICK ACIER 2015 GROS DIAMETRE SILVER	

	24700/152FMH	Gearshift Pedal	SELECTEUR	
--	--------------	-----------------	-----------	---

CARBU





	YC110-38424	Carburetor RSP/SM150/C/CP/FP 2012 with main jet 107.5 and slow jet 15	Carburateur RSP/SM150/C/CP/FP 2012 GICLEUR 107.5 GICLEUR 15	
	GB5787-M6x30-W	Hex. Bolt with Flanged Face M6X30 for carburetor fixation on inlet pipe	vis M6X30 pour fixation carbu sur pipe admission	
	GB6170-M6-W	Hex flanged self locking nut M6 for carburetor fixation on inlet pipe	écrou M6 pour fixation carbu sur pipe admission	
	YC110-3847-01	Carburetor spring d17x70mm	Ressort Carbu	

CARTONS - CAISSES MOTOS

	YC110-CARTON-CP	BIKE BOX CLASSIC 1520x380x840mm	CARTON EMBALLAGE MOTO CLASSIC	
	YC110-FOAMBOX	Foam box 2014 420x340x160mm	Cale PS	
	YC110-FILM	Protective film for seat 600x600x0.02mm	Protection plastique pour Selle	

	YC110-2101-03	Silicagel	Silicagel	
--	---------------	-----------	-----------	---

CATALOGUES - FICHES MOTOS - FICHES STICKER

	YC110-0700-01	Accessory tools	Trousse a outils	
	YC110-0700-0201	Owner manual 2015	Manuel Utilisation 2015	
	YC110-0700-0401	Vin Plate 2015	Plaque Vin 2015	
	YC110-0700-03	A4 sheet assy	Fiche A4	

2019

0 2019

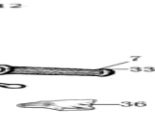

Qty/Blake	Model
1	SM1501219/SP11216/SP21219/SP31215
1	SM1501219/SP11216/SP21219/SP31215
1	SM1501219/SP11216/SP21219/SP31215
1	SM1501219/SP11216/SP21219/SP31215

1	ALL BIKES 1219
1	P1501419/SM1501419/ SP11416/SP21419/SP31 419
1	ALL BIKES 1219
1	ALL BIKES 1219
1	ALL BIKES 1219
1	ALL BIKES 1219
1	ALL BIKES 1219
1	SP21819/SP31819/BIGY1501 819/BIGYFD1901819/BIGYZE 1901819
1	F1251419/P1251419/P15014 19/SM1501419/SP11419/SP 21419/SP31419/BIGY19
1	SP21819/SP31819/BIGY1501 819/BIGYFD1901819/BIGYZE 1901819
1	SM1501319/SP11316/S P21319/SP31319

1	ALL BIKES 1719 (BUT50A/50E/SP3/BIGY 125/FD190MX)
1	ALL BIKES 1219 (BUT50/F88s/F88se)
1	ALL BIKES 1719 (BUT50E)
2	ALL BIKES 1219 (BUT50A)
2	F125L1619/F1251216/P1251 419/P1501419/SM1501219/ SP11216/SP21219/SP31219
1	SP21819/SP31819/BIGY1501 819/BIGYFD1901819/BIGYZE 1901819
1	SP21819/SP31819/BIGY1501 819/BIGY190D1918/BIGYZE1 901819
1	F125L1619/F1251216/P1251 419/P1501419/SM1501219/ SP11219/SP21219/SP31219
1	F125L1619/F1251216/P1251 419/P1501419/SM1501219/ SP11219/SP21219/SP31219
2	ALL BIKES

2	ALL BIKES
5	ALL BIKES
1	C1112/SM1501119/SP1 1416
1	ALL BIKES 1219
1	ALL BIKES 1219
1	ALL BIKES 1219
1	ALL BIKES 1219
1	ALL BIKES 1219
2	ALL BIKES 1219
1	ALL BIKES 1219 (BUT50A)
1	F88s1819/F88se1819/F125L 1819/F1251819/F125s1819/ F125se1819/P88s1819/P125 1819/P1501819/SM125s181 9

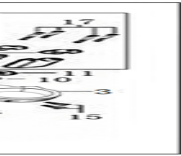
1	F88s1819/F88se1819/F125L1819/F1251819/F125s1819/F125se1819/P88s1819/P1251819/P1501819/SM125s1819/BIGY1251819/1501819
1	BIGY1251819/1501819
1	ALL BIKES 1219
1	SP21819/SP31819/BIGY1501819/BIGYFD1901819/BIGYZE1901819
1	SP21819/SP31819/BIGY1501819/BIGYFD1901819/BIGYZE1901819
1	SP21819/SP31819/BIGY1501819/BIGYFD1901819/BIGYZE1901819
1	SP21819/SP31819/BIGY1501819/BIGYFD1901819/BIGYZE1901819
1	P1251619/P1501419/S1501419/SP11419/SP21419/SP31419
	

Qty/Bike	Model
1	ALL BIKES 1219 (BUT50A/F88s/F88se)
1	F88s1419/F88se1519/F1251419/F125s1419/F125se1519/SM125s1419/SM1501519/SP11416/BIGY1251719/1501719
1	F88s1419/F88se1519/F1251419/F125s1419/F125se1519/SM125s1419/SM1501519/SP11416/BIGY1251719/1501719
2	ALL BIKES 1219 (BUT50A/F125L/SP)
2	ALL BIKES 1315/ALL BIKES 1619 (BUTF125L/SP3)
	F125se1719/SM12519
1	ALL BIKES 1219 (BUT50A/F88s/F88se)
1	ALL BIKES 1219 (BUT50A/F88s/F88se)
1	ALL BIKES 1219

3	ALL BIKES 1219
1	ALL BIKES 1219
1	ALL BIKES 1419 (BUT50A/F88s/F88se/P88s)
4	ALL BIKES 1219 (BUT50A/SP3/BIGY190C)
4	ALL BIKES 1219 (BUT50A)
4	ALL BIKES 1219 (BUT50A)
4	ALL BIKES 1219 (BUT50A)
4	ALL BIKES 1219
1	ALL BIKES 1219
2	ALL BIKES 1219

1	ALL BIKES 1219
1	ALL BIKES 1219
1	F1251419/F125s1419/F125se1519/SM125s1419/SM1501519/BIGY1251719/1501719
1	ALL BIKES 1219 (BUT50A/SP1/SP2/SP3)
1	ALL BIKES 1419 (BUT50A/F88s/F88se/P88s)
1	ALL BIKES 1419 (BUT50A/F88s/F88se/P88s)
1	ALL BIKES 1419 (BUT50A/F88s/F88se/P88s)
1	ALL BIKES 1419 (BUT50A/F88s/F88se)

Qty/Bike	Model
1	F125se1719/SM19
3	ALL BIKES 1219

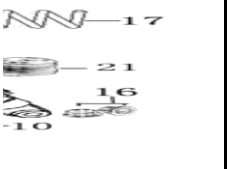
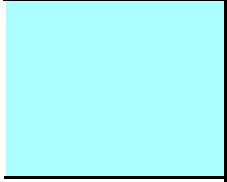

Qty/Bike	Model
1	P1251519/P1501319/S M1501319
1	P1251619/P1501619/S M1501619
1	P88s1315/P1251319/P1501319/SM1501319
1	P1251519/P1501319/S M1501319

1	P1251619/P1501619/S M1501619/SP1619
1	P88s1316/P1251319/P15013 19/SM1501319/SP11316/SP 21319/SP31319
1	P88s1316/P1251319/P15013 19/SM1501319/SP11316/SP 21319/SP31319
2	ALL BIKES 1219 (BUT50A)
1	P1251619/P1501619/S M1501619/SP1619
6	P12519/P15019/SP2-3- 19/SM15019/BIGY19
2	ALL BIKES (BUT 50A- E/F88L/125L/SP1-2- 3/BIGYF150/BIGY190FD /BIGY190ZE)
2	P88s1315/P1251319/P1 501319/SM1501319/BI GY12519/150MX19
1	P1251619/P1501619/S M1501619/SP1619
1	ALL BIKES 1219 (BUT 50A)

2	ALL BIKES 1419 (BUT50A/F88s/F88se/P88s)
2	ALL BIKES (BUT 50A-E)
1	P1251619/P1501619/S M1501619
2	SM12519/BIGY1251 719/1501719
2	SM12519/BIGY1251 719/1501719

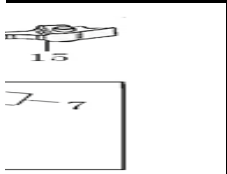

Qty/Bike	Model
1	P1251619/P1501619/SP1619 /SM1501619
1	ALL BIKES 1219 (BUT 50A/F88s/F88se/F88L/F125L)

1	ALL BIKES 19 (BUT50A)
1	P1251619/P1501619/S M1501619/SP11619/SP 21619
1	ALL BIKES 1219 (BUT50A)
2	ALLBIKES 1215 (BUT 50A/F88s/F88se)/F1251619/ F125s1619/F125se1619/P12 51619/P1501619/SP116/SM 1619/BIGY1251719/1501719
2	ALL BIKES 1219 (BUT50A)
1	ALL BIKES 1219 (BUT50A)
1	ALL BIKES 1219 (BUT50A)
1	ALL BIKES 1215 (BUT50A/F88s/F88se)/F125L 1619/F1251619/F125s1619/ F125se1619/P1251619/P150 1619/SP11416/SM1619/BIG Y1251719/1501719
1	P1251619/P1501619/S M1501619/SP11619
2	SM12519/BIGY1251719 /1501719

2	ALL BIKES 1219 (BUT50A/F88s/F88se)
1	ALL BIKES 19 (BUT50A)

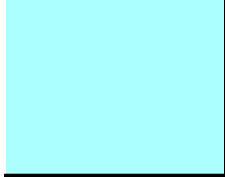

Qty/Bike	Model
1	SM1619
1	SM1219
1	SM1219
1	ALL BIKES
1	SM1519

1	ALL BIKES1315(BUT50A)/ALL BIKES1619(BUT50A/SP2/SP3)
2	ALL BIKES1315(BUT50A)/ALL BIKES1619(BUT50A/SP2/SP3)
1	ALL BIKES15(BUT50A)/ALL BIKES1619(BUT50A/SP2/SP3)
1	ALL BIKES1215(BUT50A)/ALL BIKES1619(BUT50A/SP2/SP3)
1	P88s1215/SM1219
1	SM1319
1	ALL BIKES 1619 (BUT50A/F88s/F88se)
4	ALL BIKES1619 (BUT50A)
1	ALL BIKES1619 (BUT50A)
1	SM1219

1	SM1219
2	ALL BIKES139(BUT50A)
1	ALL BIKES 1215 (BUT50A/SPII/SPIII)/ALL BIKES 1619 (BUT50A/SP/BIGY)
2	SM1019
2	SM1019
	
Qty/Bike	Model
1	ALL BIKES 1319 (BUT50A/BIGY125)
2	ALL BIKES 1119

2	ALL BIKES 1119
1	ALL BIKES 1119
1	ALL BIKES
1	ALL BIKES
1	ALL BIKES
1	ALL BIKES
1	ALL BIKES
2	ALL BIKES 1419 (BUT50A/F88s/F88se/P 88s)
1	50A1319/F88s1316/F88se15 19/F88L17/F125L1619/F150L 17/F1251316/F125s1319/F1 25SE1519/SM1251319
1	50A1319/F88s1316/F88se15 19/F88L17/F125L1619/F150L 17/F1251316/F125s1319/F1 25SE1519/SM1251319
1	ALL BIKES

1	ALL BIKES
1	ALL BIKES
2	ALL BIKES
1	ALL BIKES 1319
1	ALL BIKE 1319 (BUT50A)
1	ALL BIKES 1319 (BUT50A/50E/BIGY125)

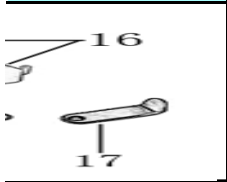
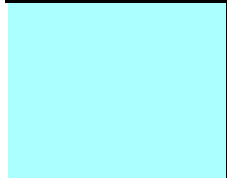

Qty/Bike	Model
1	P1251619/P1501619/S M1501619

1	ALL BIKES1219 (BUT50A)
1	SP21819/SP31819/BIGY 1819
1	P1251619/P1501619/SP 1219/SM1501619/BIGY 19
1	P1251619/P1501619/SP 1219/SM1501619/BIGY 19
4	SP1219/BIGY19
1	P1251619/P1501619/SM150 1619/SP1319/BIGY19
1	P1251619/P1501619 /SM1501619
1	P1251619/P1501619 /SM1501619
2	
2	SP1219/BIGY1719

1	P1251619/P1501619 /SM1501619
4	SP1219/BIGY19
1	P1251619/P1501619 /SM1501619
4	SP1219/BIGY19
1	P1251619/SM15016 19
1	SM1219
1	SM1219
1	ALL BIKES 1419 (BUT50A/F88s/F88se/P 88s)
1	SM1501419
1	SM1501419

1	P1251519/P1501519 /SP1216/SM1501519/BIGY1719
1	SM1219
1	SM1219
2	SM1219
2	SM1219
2	ALL BIKES
Qty/Bike	Model
1	F88s1319/F88se1519/F88L1619/F125L1619/F1251319/F125s1319/F125se1519/P88s1315/P1251319/P1501319/SM1319/BIGY12517/1501719

1	F88s1319/F88se1519/F88L1619/F125L1619/F1251319/F125s1319/F125se1519/P88s1315/P1251319/P1501319/SM1319/BIGY12517/1501719
1	ALL BIKES 1219 (BUTSP/BIGY125/BIGYF150/FD190MX)
1	ALL BIKES 1219 (BUTSP/BIGY125/BIGYF150/FD190MX)
2	ALL BIKES1419 (BUT50A/50E/SP1/SP2/SP3)
2	ALL BIKES 1119
2	ALL BIKES 1319
1	F125L1619/F150L19/F1251316/P1251319/P1501319/SM1501319
2	ALL BIKES 1419 (BUT50A/F88s/F88se/P88s)
1	F88L17/F125L1619/F150L17/F1251316/F125s1319/F125SE1519/P88s1315/P1251319/P1501319/SM13-19
1	ALL BIKES 1419 (BUTSP1/SP2/SP3)

1	ALL BIKES 1419 (BUTSP1/SP2/SP3)
1	ALL BIKES 1419 (BUTSP1/SP2/SP3)
1	ALL BIKES 1419 (BUTSP1/SP2/SP3)
1	SM1319
2	SM1219
2	SM1219
2	SM1219
8	SM1219
8	P1251519/P1501519/SP 1219/SM1501519/BIGY 1719
8	SM1219

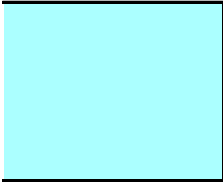

Qty/Bike	Model
1	P1251819/P1501819/S M1819/BIGY1819
	P1251819/P1501819/S M1819/BIGY1819
2	F88L17/F88s1216/F88se151 9/F125L1619/F150L17/F125 1216/F125s1219/F125SE151 9/P88s1215/P1251319/P150 1319/SM1219/SP1617
2	ALL BIKES 1219 (BUT50A)
2	ALL BIKES 1219 (BUT50A)
2	F88s1219/F88se1519/F1251 219/F125s1219/F125se1519 /P88s1315/P1251319/P1501 319/SM1219/SP116/BIGY12 51719/1501719
1	P1251519/P1501519/SP1219 /SM1501519/BIGY19

1	ALL BIKES1215(BUTSP1/SP2/SP3) / ALL BIKES1619(BUTSP2/SP3)
5	ALL BIKES 1519 (BUTSP2/SP3)
5	ALL BIKES 1519(BUTSP2/SP3)
1	P1251819/P1501819/S M1819/BIGY1819
1	P1251819/P1501819/S M1819/BIGY1819
1	P88s1315/P1251319/P15013 19/SM1501319
1	SM1619
1	ALL BIKES1619 (BUT50A)
1	P1251519/P1501519/SP1219 /SM1501519/BIGY19
1	P1251519/P1501519/SP1219 /SM1501519/BIGY19

1	P1251519/P1501519/SP1219 /SM1501519/BIGY19
1	P1251519/P1501519/SP1219 /SM1501519/BIGY1719
5	ALL BIKES 1519(BUTSP2/SP3)
1	P1251519/P1501519/SP1216 /SM1501519/BIGY1719
1	ALL BIKES 1219 (BUT50A)
2	SM12519/BIGY1251719/150 1719
2	ALL BIKES 1219
1	P1251519/P1501519/SP1216 /SM1501519/BIGY1719
1	ALL BIKES 1219 (BUT50A)
1	ALL BIKES 1219(BUT50A)

3	ALL BIKES 1219(BUT50A)
3	ALL BIKES 1219
1	P1251519/P1501519/SM150 1519
1	All BIKES (BUT50E)
1	ALL BIKES 19 (BUT50A)
3	ALL BIKES 1419 (BUT50A/F88s/F88se/P 88s)
2	SP1219/BIGY1719
Qty/Bi ke	Model

1	SM1619
1	SM1219
1	SM1219
1	ALL BIKES
1	SM1519
1	SM1219
1	ALL BIKES 1219 (BUT50A/SP/BIGY)
2	ALL BIKES1315(BUT50A)/ALL BIKES1619(BUT50A/SP2/SP3)
1	F88s1219/F88se1519/F125L 1619/F1251219/F125s1219/ F125se1519/P88s1215/P125 1319/P1501319/SM1219/SP 116/BIGY1251719/1501719
1	F88s1219/F88se1519/F125L 1619/F1251219/F125s1219/ F125se1519/P88s1215/P125 1319/P1501319/SM1219/SP 116/BIGY1251719/1501719

1	50A1617/F125L1619/F150L17/F1251216/F125s1219/F125SE1519/P1251319/P1501319/SM1219
2	ALL BIKES 1319 (BUTSP1/SP2/SP3/BIGY)
4	F88s1316/F88se1519/F88L17/F125L1619/F150L17/F1251316/F125s1319/F125SE1519/P88s1315/P1251319/P1501319/SM1319
1	ALL BIKES 1619 (BUT50A)
4	ALL BIKES1619 (BUT50A)
1	P88s1215/SM1219
2	ALL BIKES139(BUT50A)
1	SP21319/SP31319/SM13-19
2	SM1019
2	SM1019

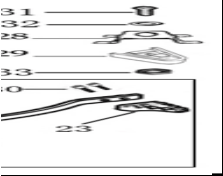
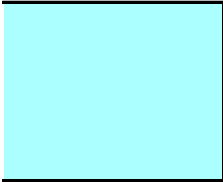

Qty/Bike	Model
1	ALL BIKES 1215 (BUT50A)/ALL BIKES 1619 (BUT50A/SP2/SP3)
1	P1251619/P1501619/S M1501619/BIGY19
1	P1251619/P1501619/SM150 1619/SP11619
2	ALL BIKES 1215(BUT50A/F88s/F88se)/A LL BIKES 1619 (BUT50A/F88s/F88se/F125L/ SP2/SP3)
1	P88s1315/P1251319/P15013 19/SM1501319/BIGY12519/ 15019
1	ALL BIKES 1314 (BUT50A)/ALL BIKES 1519 (BUT50A/SP1/SP2/SP3)
1	ALL BIKES 1219 (BUT50A)

1	ALL BIKES 1219 (BUT50A)
2	P1251519/P1501519/SP1216 /SM1501519/BIGY1719
1	P1251619/P1501619/S M1501619
1	ALL BIKES1215(BUT50A)/ALL BIKES1619(BUT50A/SP2/SP3)
2	ALL BIKES1215(BUT50A)/ALL BIKES1619(BUT50A/SP2/SP3)
1	P88s16/P1251619/P1501619 /SM1501619/SP1619/BIGY1 9
1	P88s13- 15/P1251319/P1501319 /SM1501319/BIGY125M X19/150MX19
1	ALLBIKES1215(BUT50A)/F88s 1619/F88se1619/F125L1619 /F1251619/F125s1619/F125s e1619/SM125s1619/BIGY12 51719/1501719
1	F88s1219/F88se1519/F125L 1619/F1251219/F125s1219/ F125se1519/P88s1215/P125 1319/P1501319/SM1219/Bi GY12517/1501719
1	P1251619/P1501619/SP1619 /SM1501619/BIGY19

1	P88s13-15/P1251319/P1501319/SM1501319/BI/GY12519/150MX19
1	SM1219
1	SM1219
2	F88s1319/F88se1519/F125L1619/F1251319/F125s1319/F125se1519/P88s1315/P1251319/P1501319/SM1319/BI/GY12517/1501719
1	SM1219
1	ALL BIKES 1219
1	ALL BIKES (BUT 50A-E)
1	P12519/P15019/SM15019/S19/BI/GY19
2	P12519/P15019/SM15019/S19/BI/GY19
2	ALL BIKES 1219

4	P1251719/P1501719/SM1501719/SP1719/BIGY1719
---	---



Qty/Bike	Model
1	F88s1516/F88se1519/F88L17/F125L1619/F150L17/F1251516/F125s1519/F125SE1519/P88s15/P1251519/P150151617/SM1519
1	P88s15/P1251519/P1501519/SM1501519
1	ALL BIKES1219(BUT50A)
2	ALL BIKES (BUT 50A-E)
1	F88s1316/F88se1617/F125L16/F1251316/F125s1319/F125SE1519/SM1251319
1	F88s1316/F88se1519/F88L17/F125L1619/F150L17/F1251316/F125s1319/F125SE1519/SM1251319/SP11316/SP21319/SP31319

1	F88s1219/F88se1519/F125L1619/F1251219/F125s1219/F125se1519/P88s1215/P1251319/P1501219/SP11216/S M1219/BIGY1251719/BIGY1501719
1	P88s15/P1251519/P1501519/SM1501519
1	ALL BIKES1214(BUT50A)/ALL BIKES1519(BUT50A/SP)
1	ALL BIKES1219 (BUT50A)
1	ALL BIKES 1214 (BUT50A)/ALL BIKES 1219 (BUT50A/SP2/SP3)
1	P88s13-15/P1251319/P1501319 /SM1501319
3	ALL BIKES 1319
3	SM12519/BIGY1251719 /1501719
3	ALL BIKES 1219
1	F88s1216/F88se1519/F88L1719/F12511619/F1501719/F1251216/F125s1219/F125se1519/P88s1215/P1251319/P1501319/SP11416/SM1219 /BIGY1251719/1501719

1	F88s1219/F88se1519/F88L1619/F125L1619/F1251219/F125s1219/F125se1519/P88s1215/P1251319/P1501219/S P11416/SM1219/BiGY1251719/1501719
3	ALL BIKES 1319
3	P1251519/P1501519/SP1219/SM1501519/BiGY1719



Qty/Bike	Model
1	P1251819/P1501819/SP21819/SP31819/SM1501819
1	P12519/P15019/SP119/SP219/SP319
1	P12519/P15019/SP119/SP219/SP319
1	P1251619/P1501619/SM1501619/SP1619

1	P12519/P15019/SP119/ SP219/SP319
1	P12519/P15019/SP119/ SP219/SP319
1	P1251619/P1501619/S M1501619/SP1619
1	P12519/P15019/SP119/ SP219/SP319
2	ALL BIKES 1519 (BUTSP2/SP3/BIGY1251 9/BIGYF150MX/FD190 MX)
2	P11251619/P1501619/S P11619/SP21619/SP316 19/SM1501619
1	ALL BIKES
4	P1251619/P1501619/SM150 1619/SP1619
4	ALL BIKES 1219
4	ALL BIKES 1219

	P88s1314/P1251314/P1501314/SM1501214-19/f88se19/F125s19/F125se19/P12519/P15019
	P88s1314/P1251314/P1501314/SM1501214-19/f88se19/F125s19/F125se19/P12519/P15019
1	ALL BIKES 1219
8	ALL BIKES 1219 (BUT BIGY)
1	P88s1315/P1251319/P1501319/SM1501319/SP11316/SP21319/SP31319
2	ALL BIKES 1319 (BUT50A)
2	ALL BIKES 1219
2	ALL BIKES 1219
2	ALL BIKES 1219
2	ALL BIKES 1219

2	P1251519/P1501519/SP 1216/SM1501519/BIGY 1719
1	P125181919/P1501819 19/SM1501819/SP2181 919/SP3181919
4	ALL BIKES 1219
4	ALL BIKES 1219

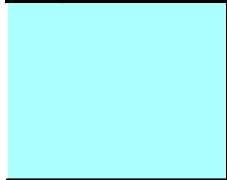

Qty/Bike	Model
1	F125L1719/F125s1719/P125 1719/P1501719/SP21719/S M1719/BIGY1251719/15017 19/F1501719
1	ALL BIKES (BUT 50A/SP3/BIGYF190FD)
1	ALL BIKES 1219 (BUT50A/SP3/BIGY125/ BIGYFD190MX)

1	F1251216/F125s1219/F125S E1519/P88s1215/P1251319/ P1501319/SM1219/SP11416 /SP21419
1	ALL BIKES 1319 (BUT50A/SP3)
1	ALL BIKES 1219 (BUT50A/50E/SP3/BIGY 125/BIGYFD190)
1	ALL BIKES 1219 (BUT50A/50E/SP3/BIGY 125/BIGYFD190MX)
1	ALL BIKES 1419 (BUT50A/F88s/F88se/P 88s)

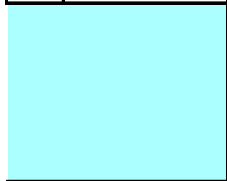

Qty/Bike	Model
1	P125181919/P1501819 19/SM1501819
1	ALL BIKES 1119 (BUT50A)

1	ALL BIKES 1416(BUT50A/SP3)/ALL BIKES 1719(BUT50A/SP/BIGY)
1	ALL BIKES 1119 (BUT50A)
1	ALL BIKES 1319
2	P125181919/P150181919/S M1819
1	F88s1316/F88se1519/F1251 316/F125s1319/F125SE1519 /P88s1315/P1251319/P1513 19/P1501319/SM1319
1	F88s1316/F88se1519/F1251 316/F125s1319/F125SE1519 /SM1251319/P88s1315/P12 51319/P1501319/SM150131 9/SP1319
4	ALL BIKES
2	ALL BIKES 1219 (BUT50A)
2	P88s1315/P1251319/P15013 19/SP11316/SP21319/SP313 19/SM1501319
1	P12519/P15019/SM150 19

1	P12519/P15019/SM15019/SP119/SP219/BIGY19
2	P1251619/P1501619/SM1501619/SP1619
1	P1251519/P1501419/SM1501419
1	P1251519/P1501419/SM1501419
1	P125181919/P150181919/SM1501819
1	P1251519/P1501419/SM1501419
4	ALL BIKES 1219
4	ALL BIKES 1119

Qty/Bike	Model
1	ALL BIKES1219 (BUT50A/F88se/F125se/LITE/SP3/BIGY125)
1	ALL BIKES 1219 (BUT50A/F88se/F125se/LITE/SP3)
1	P88s13-15/P1251319/P1501319/SP1316/SP21319/SM1501319
1	ALL BIKES 1219 (BUT50A/F88se/F125se/LITE/SP3/BIGY125)
1	ALL BIKES 1219 (BUT50A/F88se/F125se/LITE/SP3/BIGY125)
1	P88s1315/P1251319/P1501319/SP11316/SP21319/SM1501319
	
Qty/Bike	Model

1	ALL BIKES1319
1	SP11316/SM1501319
1	P1501619/SM1501619
2	ALL BIKES 1319 (BUT50A)
1	ALL BIKES201519 (BUT50A/SP3190)/BIGY1719(BUT190C)
1	ALL BIKES1519(BUT50A/SP3190)/BIGY1719(BUT190C)
1	ALL BIKES1519(BUT50A/SP3190)/BIGY1719(BUT190C)
1	ALL BIKES1519 (BUT50A/SP3190)
1	P1501519/SM1501519/SP1519

1	F88se1519/F1251316/F125se1519/P1251319/P1501319/SM1501319/SP1319
1	P1501319/SM1501319/SP11319/SP21319/SP31501319
2	ALL BIKES 1219
2	ALL BIKES (BUT 50A-E)
1	F1251319/F125s1319/F125se1519/P1251319/P1501319/SP11316/SP21319/SP31501315/SM1319/BIGY1251719/1501719/1501719
1	CP12/FP12/P1251519/P1501519/SM1501519/SP11319/SP21319/SP31315
1	ALL BIKES 1419
1	ALL BIKES 1419

6	ALL BIKES
1	ALL BIKES
1	ALL BIKES 1319
1	ALL BIKES 1319
1	ALL BIKES