



YCF-Racing.com

BIGY-125-STD

YCF 125 MX

BIGY

2





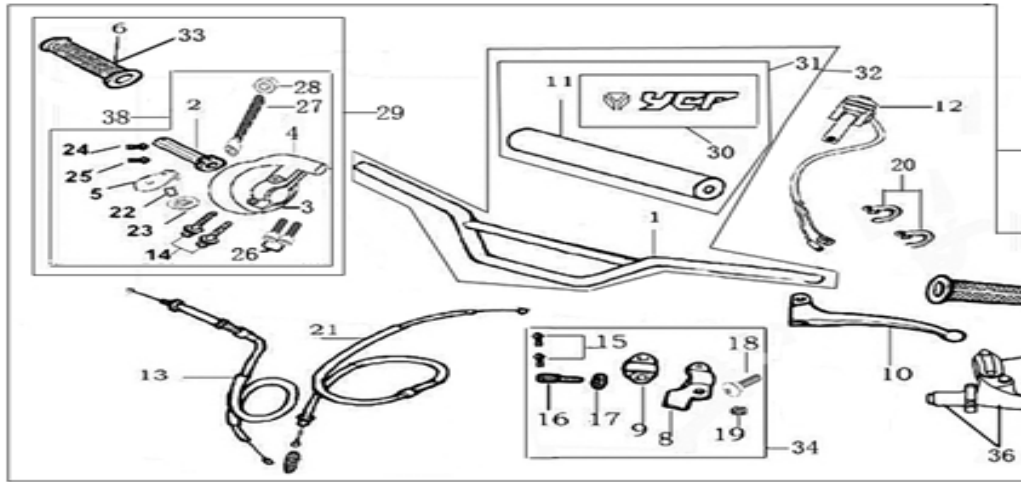









Handle bar assembly



N°	Ref.	Description	Français	Picture
1	YC110-0101-16-BK	Handle Bar Chromolly L=780mm BLACK	Guidon chromolly L=780mm NOIR	
2	YC110-01021-01	YCF Throttle Body 2012-17 BLACK	plastique poignée de gaz YCF 2012-17 NOIR	
3	YC110-01021-04	YCF Lower Throttle Body Housing 2012	dessous poignée gaz YCF 2012	
4	YC110-01021-03	Upper Throttle Body Housing YCF 2012-17	dessus poignée gaz YCF 2012-17	
5	YC110-01021-02	Upper Throttle Body Housing Cover YCF 2012-17	plastique du dessus poignée gaz YCF 2012-17	
6	YC110-01-01-GY	YCF Right Grip GREY	Poignée caoutchouc droite YCF GRISE	
7	YC110-01-02-GY	YCF Left Grip GREY	Poignée caoutchouc gauche YCF GRISE	
8	YC110-0108-06	Clutch upper bracket 2018 SILVER	cocotte basse embrayage 2018 SILVER	
9	YC110-0109-05	Clutch lower bracket 2014-17 SILVER	Demi cocotte embrayage 2014-17 SILVER	

10	YC110-0110-03	Clutch lever 2018 (with FB13-d8xd10x6-Cu 1EA+FB13-d8xd10x8-Cu 1EA)	levier embrayage 2018	
11	YC110-0110-01	Bar pad for Chromolly Handlebar d14xd43x250mm	Mousse guidon pour guidon Chromolly d14xd43x250mm	
12	YC110-0105-15	Kill Switch ON/OFF L=580mm	Coupe circuit on off L=580mm	
13	YC110-0106	Throttle Cable L=840mm A+B=125	Cable gaz L=840mm A+B=125	
	YC110-0143-01	RUBBER ON THROTTLE CABLE		
14	GB5787-M6x22-G	Hex. Bolt with Flanged Face M6x22 for fron brake	vis M6x22 pour frein avant	
15	GB5787-M6x20-G	Hex. Bolt with Flanged Face M6x20 for clutch bracket	vis M6x20 pour cocotte embrayage	
	YC110-0144-01	Aluminium adjust screw for 2018 clutch lever	Molette Reglage aluminium pour Levier embrayage 2018	
	YC110-0150-01	Clutch Adjust bolt for 2018 clutch lever	Tendeur cocotte pour Levier embrayage 2018	
18	27-06025B	Clutch Stepped bolt M6x25	vis cloche embrayage M6x25	
19	6183-06000B	Cltch Self-lock Nut M6	ecrou cloche embrayage M6	
20	YC110-01-03-BK	Tape 150mm BLACK	colier maintien cable 150mm NOIR	
20	YC110-01-03-WH	Tape 150mm WHITE	colier maintien cable 150mm BLANC	
20	YC110-01-05-BK	Tape 350mm BLACK	colier maintien cable 350mm NOIR	
20	YC110-01-05-WH	Tape 350mm WHITE	colier maintien cable 350mm BLANC	
21	YC110-0109-04	Clutch Cable Assy.L=950mm A+B=70mm	cable embrayage L=950mm A+B=70mm	
22	YC110-0102-08	YCF Throttle cable Bearing d8xd16x5mm	Roulement poignee gas YCF d8xd16x5mm	

23	YC110-0102-07	YCF Throttle cable guide pulley plastic d12xd16xd28x8mm	Roulette plastique Poignee Gas YCF d12xd16xd28x8mm	
24	GB819-M4x12	Plus screw M4x12 for Upper Throttle Body Housing Cover	vis M4x12 plastique du dessus poignée gaz	
25	GB819-M4x20	Plus screw M4x20 for Upper Throttle Body Housing Cover	vis M4x20 plastique du dessus poignée gaz	
26	GB70-M6x20-B	Hex. Bolt M6x20 BLACK	vis M6x20 NOIR	
30	YC110-0130-05	PVC for Bar Pad suitable Chromolly Handlebar 246mmx156mm 2018 BLACK-WHITE	PVC mousse guidon Chromolly 246mmx156mm 2018 NOIR-BLANC	
31	YC110-0131-02	Complete Bar Pad for Chromolly Handlebar L=250mm 2018 BLACK	Mousse guidon complete pour guidon Chromolly L=250mm 2018 NOIR	
32	YC110-0132-02	Chromelly Handle Bar with bar pad and pvc L=780mm BLACK	Guidon chromolly complet avec Mousse et Pvc L=780mm NOIR	
33	PPC010-GY	YCF set of grip GREY	Paire de poignée caoutchouc YCF GRISE	
34	YC110-0134-03	Clutch bracket Assy. 2018 SILVER	Cocotte embrayage complete 2018 SILVER	
35	YC110-0135-01	Cnc adjustable bracket with lever 2018	Cocotte CNC réglage rapide avec levier embrayage 2018	
51	YC110-0151-01	Rubber on clutch lever adjustable screw 2018	Caoutchouc levier embrayage molette réglage2018	
36	YC110-0136-01	Rubber on clutch lever 2018	Caoutchouc levier embrayage 2018	
38	YC110-01022-N	YCF Throttle Assy. 2014 -17without grip (with YC110- 0102-08 1EA)	Poignee gaz réglable YCF 2014-17 nue	

Steering stem assembly

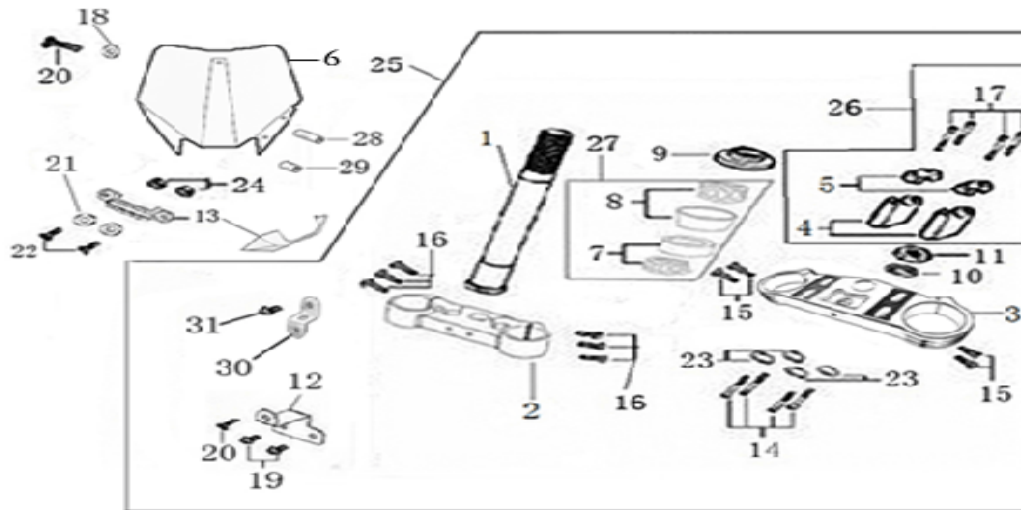



N°	Ref.	Description	Français	Picture
1	YC110-0201-03	Steering stem 233 mm	tige colonne direction 233 mm	
2	YC110-0202-39-BK	Lower triple clamp 160 mm d48mm 2014-17 MATT BLACK	té fourche inferieur 160 mm d48mm 2014-17 NOIR MAT	
3	YC110-0201-39-BK	Top Triple Clamp 160mm d45mm 2014-17 (not adjustable) MATT BLACK	té fourche supérieur 160 mm d45mm (non ajustable) 2014-17 NOIR MAT	
5	YC110-0202-04	Top Bar Mout CNC d22.2 mm/height 18mm START Type BLACK	pontet guidon supérieur d22.2 mm Type START NOIR	
4	YC110-0203-23	Lower Bar Mount CNC START type, not adjustable d22.2 / height 55 mm BLACK	Pontet guidon inférieur non ajustable type START d22.2 / hauteur 55 mm NOIR	
6	YC110-0212-09-YE	Front Number Plate BIGY 2017 YELLOW	PLAQUE AVANT BIGY 2017 JAUNE	
7	297-46/23.5	Lower Taper roller bearing 46/23.5	roulement inférieur 46/23.5	
8	297-46/22	Top Taper roller bearing 46/22	roulement supérieur 46/22	
9	YC110-02-09	Top nut for steering d52	Ecrou crantellé colonne direction d52	
10	YC110-02-10	Washer for steering stem nut d22.5xd36x0.7	Joint colonne direction d22.5xd36x0.7	
11	YC110-02-11	Nut for steering stem M22	Ecrou supérieur colnne direction M22	
13	YC110-0214-01-WH	YCF Break Line Retainer 2014-17 White (with GB9074.5-M4x10-W 1EA)	Guide durite sur plaque avant 2014-17 YCF Blanc	

14	GB70-M8x30	Stud screw M8x30 for bar mount bottom	vis M8x30 pour dessous pontet	
15	GB70-M6x25	Stud screw M6x25 for clamp top / bottom	vis M6x25 pour te superieur / inferieur	
17	GB70-M8x25	Stud screw M8x25 for top bar mount	vis M8x25 pour pontet superieur	
23	GB93-d8-W	Spring washer d8mm for bar mount bottom	Rondelle d8mm pour dessous pontet	
18	GB97-d6-W	flat washer d6 for Number plate bracket	rondelle d6 Support plaque avant	
19	GBT5787-M6x16-3	Hex. Bolt with flanged M6x16 front mudguard (spacer 3 mm)	vis M6x16 garde boue avant (deport 3 mm)	
20	GB9074.5-M6x12-W	Plus screw M6x12 (for bottom front No plate)	vis m6x12 bas plaque No avant	
21	GB97-d4-W	flat washer d4 (for bottom front No plate)	rondelle d4 bas plaque No avant	
22	GB818-M4x10-W	Plus screw M4x10 (for bottom front No plate)	vis M4x10 bas plaque No avant	
25	YC110-02-041-BK	Complete Triple Clamp (TOP45 / BOTTOM 48) START Type 2014-17 MATT BLACK	Te Fourche Complet (TE SUP. 45 / TE INF.48 Type START 2014-17 NOIR MAT	
26	YC110-0203-05	Set of Bar mount not adjustable d22.2mm/bottom 55mm START Type BLACK (with GB70-M8x25 4EA+GB70-M8x30 4EA+GB93-d8-W 4EA)	jeu pontet guidon non ajustable d 22.2mm / pontet bas 55mm Type START NOIR	
27	KRDIRECTION46	Set of bearing for steering 46/23.5, 46/22	Kit rlt colonne direction 46/23.5, 46/22	
30	YC110-0213-08	Number plate bracket 2014	Support plaque avant 2014	
31	GB5787-M6x16-W	Hex. Bolt M6x16 for top Number plate bracket	Vis M6x16 Support plaque avant te sup.	
32	YC110-02-20	Washer for steering stem nut	Joint colonne direction	

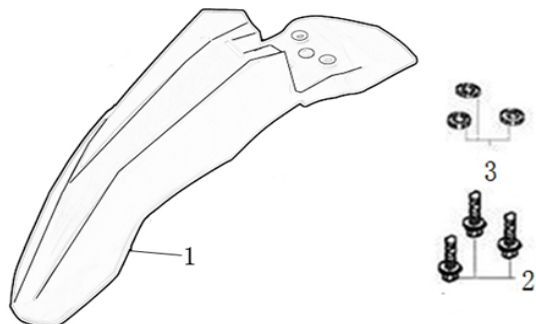
Front Fender







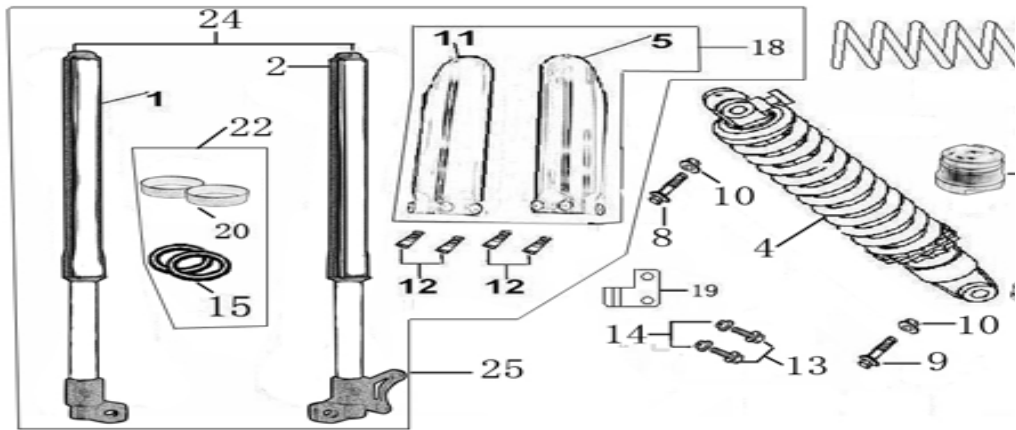

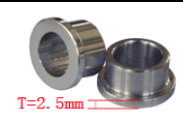

N°	Ref.	Description	Français	Picture
1	YC110-032-08-YE	Front Fender BIGY 2017 YELLWO	gb avant BIGY 2017 JAUNE	
2	GBT5787-M6x16-6	Hex. Bolt with flanged M6x16 (spacer x mm)	vis M6x16 (deport x mm)	

Front & Rear absorber





N°	Ref.	Description	Français	Picture
1	YC110-0401-23	Front right fork L=785mm (not adjustable) GREY	Tube fourche droit L=785mm GRIS	
2	YC110-0402-23	Front left fork L=785mm (not adjustable) GREY	Tube fourche gauche L=785mm GRIS	
4	YC110-0404-67	Shock absorber LB 355mmx800lbs YELLOW	Amortisseur LB 355mmx800lbs JAUNE	
5	YC110-04-015-WH	YCF Left front fork protection 735 mm WHITE	Protection fourche YCF gauche 735 mm BLANC	
8	GB5787-M12x45-W	Hex. Bolt with flanged M12x45	vis M12x45	
9	GB5787-M12x45-W	Hex. Bolt with flanged M12x45	vis M12x45	
10	GB6187-M12-W	Self-locking Nut M12	écrou M12	
11	YC110-04-024	YCF Right front fork protection 735 mm WHITE	Protection fourche droite YCF 735 mm BLANC	
12	GBT5787-M6x14	Screw with flange M6x14 (spacer x mm)	Vis avec epaulement M6x14 (deport x mm)	
16	YC110-0417-02	shock top spacer d 12 mm for mono swing arm	Entretoise amortisseur d 12 mm mono bas et haut identique	

16	YC110-0419	shock bottom spacer d12mm (same for top/bottom) LB	Entretoise amortisseur bas d 12 mm pour bras mono LB	
18	PFYCF12-WH	Set of fork protection 735 mm YCF 2012 WHITE	Jeu protection fourche 735 mm YCF BLANC	
19	YC110-0403-05	YCF oil steel line retainer on left front fork 2016-17	Passe durite YCF sur protection fourche gauche 2016-17	
13	GB5787-M6x20-W	Plus screw M6x20 for oil steel line retainer on left front fork 2016-17	Vis M6x20 pour sur protection fourche gauche 2016-17	
14	GB6170-M6-W	Nut M6 for oil steel line retainer on left front fork 2016-17	Ecrou M6 pour sur protection fourche gauche 2016-17	
24	YC110-0400-23	Pair of fork 785mm (not adjustable) GREY 2017	Jeu de fourche 785mm GRIS 2017	
	GB93-d6-W	Standard spring washer d.6	rondelle d.6	
	GB70-M6x30	Hex. Bolt M6x30 for tightening front wheel axle	vis M6x30 pour serrage axe roue avant	

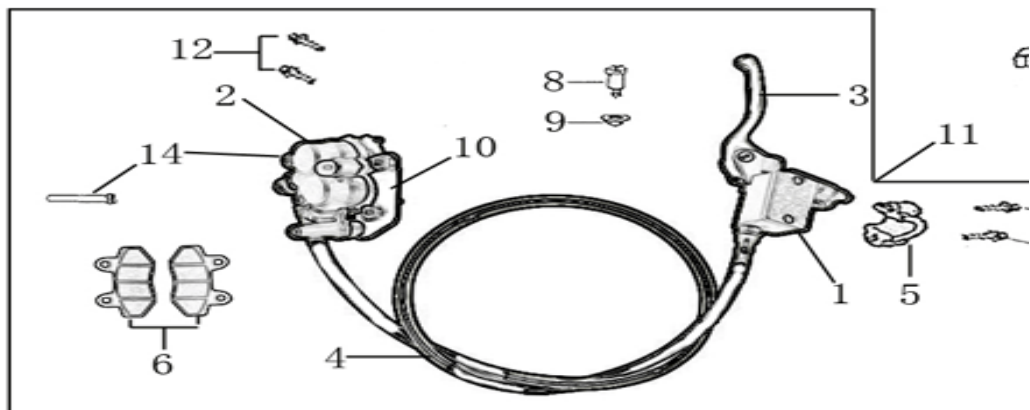
Front Brake Assy



N°	Ref.	Description	Français	Picture
1	YC110-0501-0104	Front Brake Reservoir for 2 pump d10 2016-17	maître cylindre frein avant pour étrier 2 pistons d10 2016-17	
2	YC110-0501-0205	Front Brake caliper for 2 pump w/t abestos d10	étrier frein avant double pistons sans amiante d10	
3	YC110-0517-01	Front brake lever for 2 pump brake adjustable 2019	levier frein pour frein double pistons ajustable 2019	

4	YC110-0501-0319	Front brake steel line L=1170mm d10/d10 BLACK 2016-17	durite frein avant L=1170mm d10/d10 NOIR 2016-17	
5	YC110-0501-022	Brake perch bracket for double pump	Demi cocotte frein avant pour frein double pistons	
6	YC110-0501-0403	Front Brake pads for double pump brake with copper substrate	jeu plaquette frein avant pour frein 2 pistons SANS AMIANTE	
7	GB5787-M6x22-G	Hex.bolt with flanged M6x22 for Brake perch bracket	vis M6x22 pour demi cocotte frein avant	
8	HB06-M6x25-G	Hex.bolt with flanged M6x25 front front brake lever	vis M6x25 pour levier frein avant	
9	GB6177-M6-G	Self-locking nut M6	écrou M6	
10	YC110-0501-030	Bracket for front brake 2 pumps	patte frein avant etrier 2 pistons	
11	YC110-0501-22	front brake assy 2 pumps L=1170mm d10/10 w/t abestos 2017	kit frein avant 2 pistons avec gaine plastic noire L=1170mm d10/10 sans amiante 2017	
12	GB70-M6x30	Stud screw M6x30 for front brake caliper	Vis M6x30 pour etrier frein avant	
14	YC110-0555	caliper screw for front brake L=50mm Army green	vis plaquette frein avant L=50mm	
15	YC110-0515-01	rubber for brake lever 2019	caoutchouc levier frein avant 2019	

Front Wheel Assy

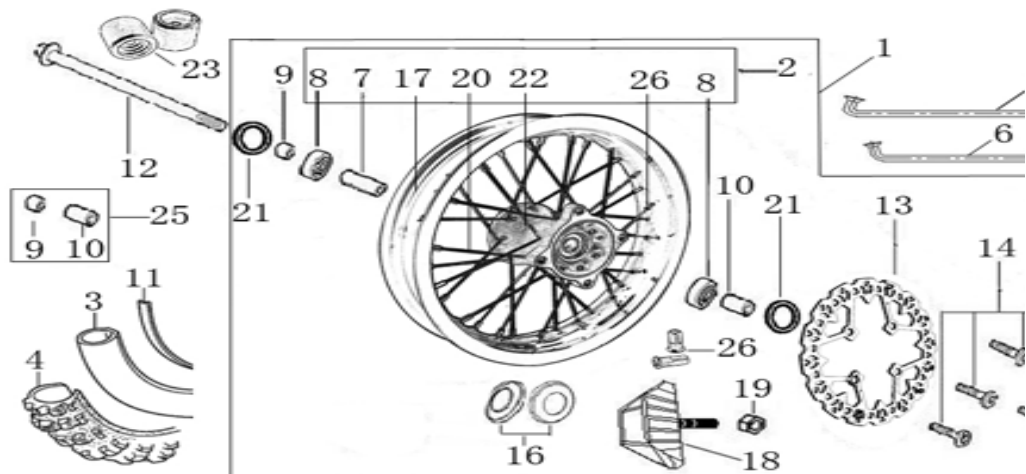

N°	Ref.	Description	Français	Picture
----	------	-------------	----------	---------







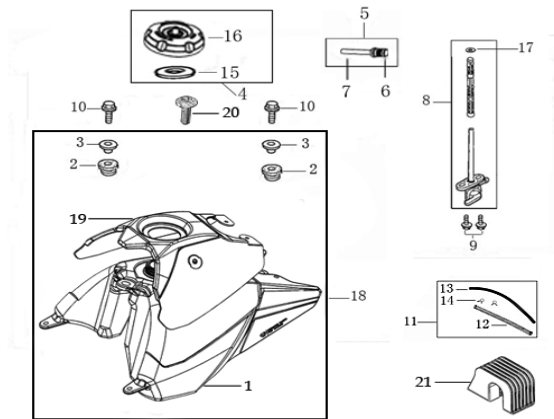

1	YC110-0601-84	Complete STEEL Front wheel 1.60x17' with disk. Casting hub	Roue avant complète ACIER 1.60x17' moyeux injecte avec disque	
2	YC110-0602-84	Complete STEEL Front wheel 1.60x17' without disk. Casting hub 2017	Roue avant complète ACIER 1.60x17' moyeux injecte sans disque 2017	
3	CHAMBRE17	Tube for front tire 70/100/17'	Chambre air 70/100/17'	
	FB6170-M8-Cr	Tire valve nut M8	Ecrou M8 pour chambre a air	
4	70/100/17	Front tyre 70/100/17 GUANGLI	Pneu 70/100/17 GUANGLI	
7	YC110-0601-02	Front axle bushing d16xd22x44	Entretoise central roue avant d16xd22x44	
8	96140-6202-2Z	Ball bearing 6202-2Z d35xd15x11	Roulement roue 6202-2Z d35xd15x11	
9	YC110-06-047	Front wheel spacer right d15xd22x23mm with STEP 2015-17	Entretoise roue avant droite d15xd22x23mm 2015- 17	
10	YC110-06-052	Front wheel spacer left d15xd22x33mm	entretoise roue avant gauche d d15xd22x33mm	
11	YC110-06-07	tire lining for 20x17'	Fond jante av 20x17'	
12	YC110-06-061	Front Axle 215 mm with Self-locking nut M14 for Marzocchi style fork	Axe de roue avant L=215 mm type marzocchi avec ecrou M14	
13	YC110-0513-02	Front disk d220 mm 2016-17	Disque frein avant d220 mm 2016-17	
14	GB70.2-M8x16	Screw for disk M8x16 for front disk	vis disque frein M8x16 pour disque avant	
15	GB6187-M14-W	Self-locking nut M14 for front wheel axle	Ecrou roue avant M14 pour axe roue avant	
17	YC110-0617-82-BK	STEEL Rim for Front wheel 1.6x17 Black	Cerceau roue av 1.6x17 ACIER Noir	
20	JR17-18.4-9K	set of front spoke 17'(184mmx24+181mmx8) 9K	Jeu rayon avant 17' (184mmx24+181mmx8) 9K	
21	YC110-0611	OIL SEAL d23xd35x5	Joint spy roue d23xd35x5	

22	YC110-0622-03	Front hub casting with oil seal 2016-17	Moyeux avant injectée avec joint spy 2016-17	
	KVD	Disk screws kit (contain GB70.2-M8x16-Cr 4EA)	KIT VIS DISQUE M8x16 (lot 4)	

Fuel Tank





N°	Ref.	Description	Français	Picture
1	YC110-0701-04	Fuel tank BIGY 2017	Reservoir BIGY 2017	
2	YC110-07-01	Cushion for fuel tank	caoutchouc pour reservoir	
3	YC110-07-02	Washer for fuel tank d12xd30x11mm	entretoise pour reservoir d12xd30x11mm	
4	YC110-0702-01	YCF Tank cap plastic 2013-17	Bouchon reservoir plastique YCF 2013-17	
5	YC125-0704-BK	Fuel tank valve BLACK	Valve prise air NOIR	
6	YC110-0704-BK	Cap of Fuel tank valve BLACK	Capuchon Valve prise air NOIR	
7	YC110-0705-BK	Fuel tank valve Hose L=40mm BLACK	Durite caoutchouc Vale prise air L=40mm NOIRE	
8	YC110-0703	Fuel cock assy.	Robinet essence	
9	GB5787-M6x12-W	Plus screw M6x12 for fuel cock	vis M6x12 pour robinet essence	
10	GB5787-M8x30-B	screw M8x30 BLACK for gas tank	vis M8x30 NOIR pour reservoir	
11	YC110-0706	fuel tank rubber line + spring d4.5xd8.5x210mm	durite reservoir avec ressort d4.5xd8.5x210mm	

12	YC110-07061	fuel tank Ispring L=180mm	ressort durite reservoir L=180mm	
13	YC110-07062	fuel tank rubber line d4.5xd8.5x210	durite reservoir d4.5xd8.5x210	
14	YC110-07063	Holding ring	collier FILTRE	
15	YC110-0720-02	Rubber mat for tank cap plastic d14xd52x2mm Oil proof	Caoutchouc bouchon reservoir YCF d14xd52x2mm	
17	YC110-0717	O-RING,d11x3mm For Fuel tank	Joint Thorique d11x3mm pour Reservoir	
18	YC110-0718-01	Complete fuel tank BIGY 2017 (with YC110-07-01 2EA+YC110-07-02 2EA)	Reservoir complet BIGY 2017	
19	YC110-0719-01	Reservoir cover Bigy 2017 Black	Couvercle Reservoir Bigy 2017 Noir	
	GB70.2-M6*12-G	Seat Fixation screw M6*12 for seat fixation	Vis Fixation Selle M6*12 pour fixation selle	
	YC110-0726-01	Bushing d6.5xd9.5x5 for Seat Fixation screw M6*12	Entretoise d6.5xd9.5x5 Vis Fixation Selle M6*12	
21	YC110-0722-01	Fixing rubber block Fuel tank BIGY 2017	Maintient Caoutchuc reservoir Bigy 2017	

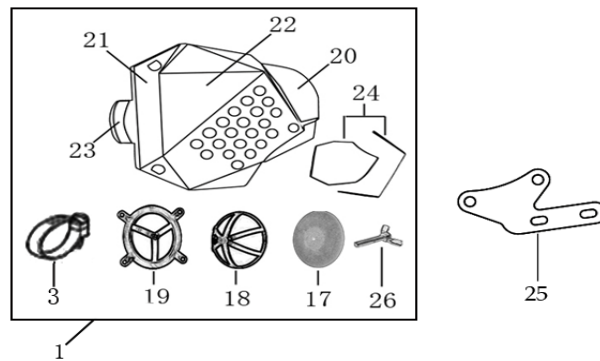
Air Filter





N°	Ref.	Description	Français	Picture
1	YC110-08-02	Air box assy 2013-17 with YCF LOGO	Boite a air complete YCF 2013-17	
3	YC110-0805	Holding ring d27-d51mm	collier Filtre d27-d51mm	
17	YC110-0817-03	YCF Air filter Foam 2018 DOUBLE THICKNESS	Mousse filtre a air YCF 2018 DOUBLE EPAISSEUR	

18	YC110-08-012	Top support for YCF air filter foam	support exterieur pour mousse filtre a air YCF	
19	YC110-08-013	Inside support for YCF air filter foam	support interieur pour mousse filtre a air YCF	
20	YC110-0820-01	Rear part of YCF air box 2015-17	Boitie arriere boite a air YCF 2015-17	
21	YC110-08-015	Front case of YCF air box	Boitie avant boite a air YCF	
22	YC110-08-026	Cover with logo of YCF air box 2013-17	Couvercle cote boite a air YCF avec logo 2013-17	
	GB70-M4x20	Hex. Bolt M4x20	vis M4x20 Couvercle cote boite 2	
	GB70-M5x20	Hex. Bolt M5x20	vis M5x20 Boitie avant boite 4	
23	YC110-08-017	Rubber link between air box and carb for YCF air box d 40 mm	Manchon boite a air YCF d 40 mm	
24	YC110-08-019	Cover Rubber Gasket of YCF air box	Joint Caoutchouc pour couvercle cote pour boite a air YCF	
24	YC110-08-020	Rubber Gasket for Rear part / front part of YCF air box	Joint Caoutchouc pour Boitie avant / Boitie arriere pour boite a air YCF	
24	YC110-08-021	Kit Rubber Gasket for Rear part / front part of YCF air box	Kit Joint pour Boitie avant / Boitie arriere pour boite a air YCF	
25	YC110-0825-02	Support of Air box BIGY 2017	Support Boite a air acier Bigy 2017	
	GB70.2-M6x20	Plus screw M6x20 for air box support	vis M6x20 pour Support Boite a air	
	GB6189-M6-W	Cltch Self-lock Nut M6 for air box support	ecrou M6 pour Support Boite a air	
26	GB62-M6x30-W	Butterfly screw M6x30	vis M6x30	

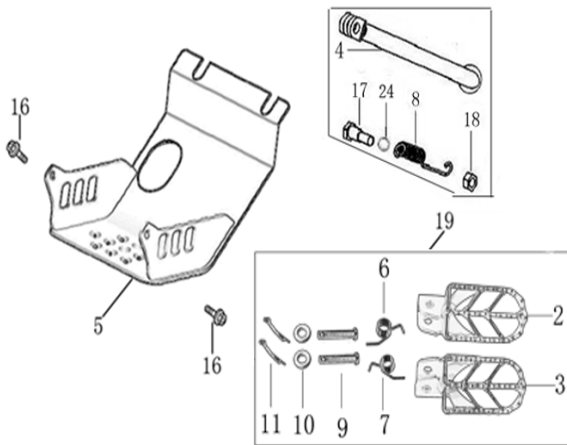
Foot Peg assy



N°	Ref.	Description	Français	Picture
2	YC110-0902-01	Right foot peg Steel START / PILOT 2013-17 GREY	Repose pied Acier droit START / PILOT 2013-17 GRIS	
3	YC110-0903-01	Left foot peg Steel START / PILOT 2013-17 GREY	Repose pied Acier gauche START / PILOT 2013-17 GRIS	
6	YC110-09-01	Spring for right steel foot peg d1.5xd16.5x10mm	ressort repose pied droit acier d1.5xd16.5x10mm	
7	YC110-09-02	Spring for left steel foot peg d1.5xd16.5x10mm	ressort repose pied gauche acier d1.5xd16.5x10mm	
9	GB882-d8x43-W	shaft pin for steel footpegs d8x43	axe repose pied acier d8x43	
10	GB97-d8-W	flat washer d8x16x1	rondelle d8x16x1	
11	GB91-d2x25-W	Cotter pin 2.0x25	goupille 2.0x25	
	YC110-0904-05	Kick stand 340mm	bequille 340mm	
17	FB02-M10x1.5x30I	Stepped screw M10x35 for kick stand	vis bequille M10x35	
18	GB6170-M10-G	Hex. Nut M10	ecrou bequille M10	
24	GB93-d10-W	Standard spring washer d10	rondelle d10	
8	YC110-19-01	spring for kick stand d2.5xd15x105	ressort bequille d2.5xd15x105	
5	YC110-207-09	Engine skid plate Steel BIGY 125Mx 2017	NEW SABOT ACIER BIGY 125Mx 2017	





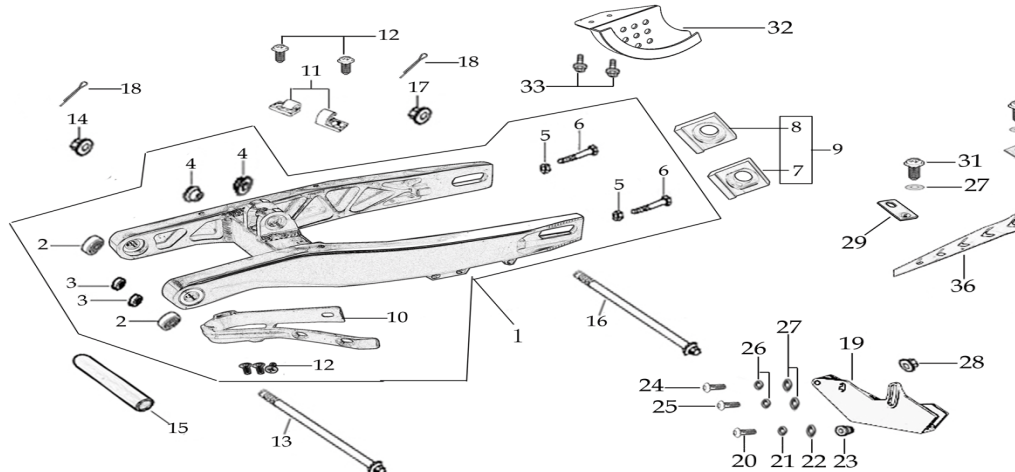

16	GB5787-M6x16-W	screw M6x16 for skid plate	vis sabot M6x16	
19	YC110-0902/10	Steel foot pegs set START / PILOT 2013-17 GREY	Jeu repose pied Acier START / PILOT 2013-17 GRIS	

Swing Arm assy







N°	Ref.	Description	Français	Picture
1	YC110-1001-15	YCF Swing arm mono Steel 460mm BIGY 2018 BLACK / BEARING d 15 mm	Bras oscillant Acier mono YCF 460mm BIGY 2018 NOIR / Roulements d 15 mm	
2	6902	Swing arm bearing d28xd15x8mm	roulement bras oscillant d28xd15x8mm	
24	YC110-1023-03	Central spacer steel swing arm BIGY125Mx / 150Mx 2017	Entretoise centrale de bras oscillant acier BIGY125Mx / 150Mx 2017	
3	YC110-1007-06	Bushing for swing arm d.15xd.20x11.5	Entrtoise bras oscillant d.15xd.20x11.5	
5	GB5783-M8x40-W	Exterior hex. Bolt M8x40	vis tendeur chaine M8x40	
6	FB6170-M8-W	Hex. Nut M8	ecrou tendeur chaine M8	
9	YC110-11-08	Block axle SILVER	Tendeur chaine SILVER	
10	YC110-10-025	Chain slider YCF Aluminium swing arm 420mm PU	Patin chaine YCF long pour Bras oscillent Aluminium YCF 420mm PU	
2	YC110-10-014-BK	Rear brake clip for BLACK	Attache durite frein arriere NOIR	
31	GB819-M6x16-W	Plus screw M6x16 for Rear brake clip	vis m6x16 pour Attache durite	

	GB6100-M6-CW	nut M6x25mm for Rear brake clip	Vis M6x25mm pour Attache durite	
9	YC110-1009-01	Swing arm shaft with self lock nut M15 L=240mm	Axe bras oscillant d10 avec ecrou M15 L=240mm	
14	GB6187-M15-W	Self locking nut M15	ecrou bras oscillant M15	
16	YC110-11-074	Rear wheel axle L=215mm with Self locking nut M14	axe roue arriere avec ecrou L=215mm avec ecrou M14	
17	GB6187-M14-W	Self locking nut M14	ecrou axe roue arriere M14	
19	YC110-1004	YCF chain guide assy for High class range BLACK	guide chaine YCF pour haut de gamme NOIR	
20	GB70.2-M5x16	Plus screw M5x16 for chain guide assy	vis M5x16 pour guide chaine	
21	GB93-d5	Standard spring washer d5 for chain guide assy	rondelle d5 pour guide chaine	
22	GB97-d5-W	Flat washer d5 for chain guide assy	rondelle d5 pour guide chaine	
23	GB6100-M5-CW	Adj. nut for YCF chain guide d5xd7xd10x13mm	Vis réglage guide chaine YCF d5xd7xd10x13mm	
24	GB70-M6x20	Stud screw M6x20 for chain guide assy	vis M6x20 pour guide chaine	
25	GB70-M6x25	Stud screw M6x25 for chain guide assy	vis M6x25 pour guide chaine	
26	GB93-d6-W	Standard spring washer d6 for chain guide assy	rondelle d6 pour guide chaine	
27	GB97-d6-W	Flat washer d6 for chain guide assy	rondelle d6 pour guide chaine	
28	GB6177-M6-W	Hex. Nut M6 for chain guide assy	ecrou tendeur chaine M6 pour guide chaine	
29	YC110-0600-02	Chain box protection support	Support Protection chaine plastique	
30	YC110-0600-021	Chain box protection support	Support Protection chaine plastique	
31	GB818-M6x12-W	Plus screw M6x12	vis M6x12	
27	GB97-d6	Flat washer d6	rondelle d6	
32	YC110-1010	YCF rear disk protection BLACK	protection disk arriere YCF NOIR	

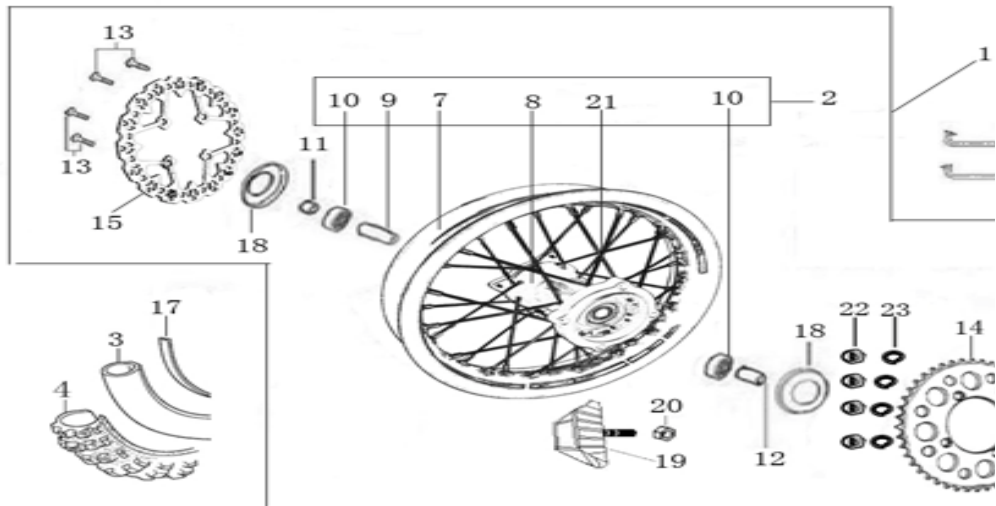
33	GB5787-M6x12-W	Plus screw M6x12 for rear disk protection	vis M6x12 pour protection disk arriere	
26	420H-116T	Chain 420H-116T, normal	Chaîne 420 116 maillons standart	
35	AR-420	Chain link	Attache rapide chaîne	
28	YC110-1028-02	Chain box protection 2019	Protection chaîne plastique 2019	
	GB9074.5-M6x12-W	Plus screw M6x12 (for bottom front No plate) for chain protection 2019	vis m6x12bas plaque No avant pour protection chaîne 2019	
	GB6189-M6-W	Hex. Flanged nut M6 for chain protection 2019	écrou M6 pour protection chaîne 2019	

Rear Wheel Assy









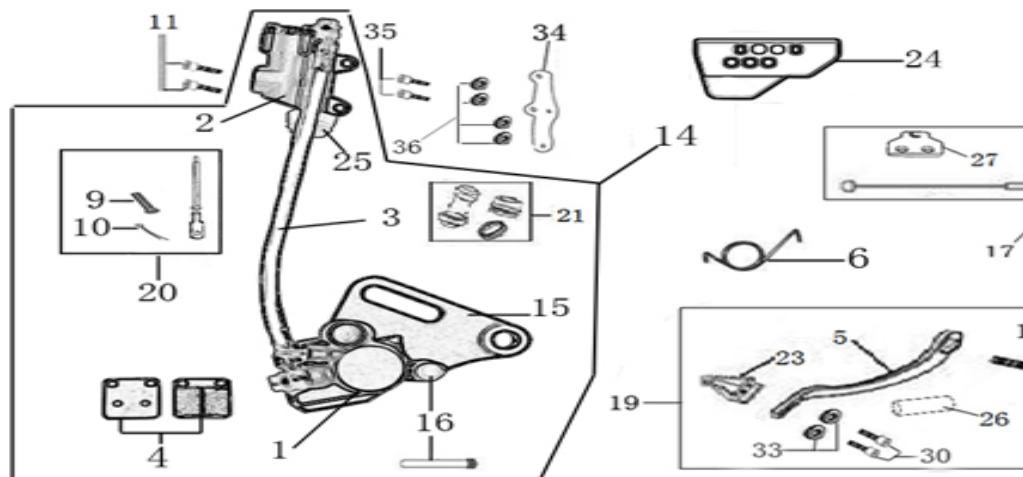

N°	Ref.	Description	Français	Picture
1	YC110-1101-64	Complete STEEL Rear wheel 1.85x14' with disk. Casting hub	Roue arriere complète ACIER 1.85x14' moyeux injecte avec disque	
2	YC110-1102-64	Complete STEEL Rear wheel 1.85x14' without disk. Casting hub 2017	roue arriere complète ACIER 1.85x14' moyeux injecte sans disque 2017	
3	CHAMBRE14-01	Tube for Rear tire 90/100-14	Chambre air 90/100-14 standard	
	FB6170-M8-Cr	Tire valve nut M8	Ecrou M8 pour chambre a air	

4	90/100/14	Rear tyre 90-100-14' Guangli	Pneu arriere 90-100-14' Guangli	
7	YC110-1107-62-BK	STEEL Rim 1.85x14 Black	Cerceau roue alu 1.85x14 ACIER Noir	
8	YC110-1122-04	Rear wheel hub Casting with oil seal 2016-17	Moyeux arriere injectee avec joint spy 2016-17	
9	YC110-1101-06	Rear hub axle bushing d16xd20x74	entretoise interieur moyeux arriere d16xd20x74	
10	96140-6202-2Z	Ball bearing 6202-2Z d35xd15x11	roulement roue 6202-2Z d35xd15x11	
18	YC110-0611	Oil seal d22xd35x5	Joint spy roue d22xd35x5	
21	JR14-15	Set of spoke 14' rear wheel Casting hub 2017 (150mmx32) 9K	jeu rayon arriere 14' (150mmx32) 9K	
11	YC110-11-041	Rear wheel spacer right d15xd22x29mm	entretoise roue arriere droite d15xd22x29mm	
12	YC110-11-052	Rear wheel spacer left d15xd22x38mm	entretoise roue arriere gauche d15xd22x38mm	
14	YC110-11-062/45	YCF Driven sprocket 420-45T 5 holes 2016-17	Couronne acier 45T YCF 2016-17	
16	BT08-M8x30-W	Exterior Hex.Bolt M8x30	vis couronne M8x30	
22	GB6189-M8-W	Cltch Self-lock Nut M8 for sprocket screw	ecrou M8 pour ecrou vis couronne	
23	GB93-d8-W	washer d8 for sprocket screw	rondelle d8 pour ecrou vis couronne	
15	YC110-1115-01	Rear Brake disc d200mm 2016-17	Disque frein arriere d200 mm 2016-17	
13	GB70.2-M8x16	Screw for disk M8x16	vis disque frein M8x16	
17	YC110-11-06	Tire lining 20x14'	Fond jante 20x14'	

KVC-2	Rear sprocket screws kit 150CC 2016	KIT vis fraisees M8x30 couronne (lot 5) pour moyeux haut gamme 2016	
KVD	Disk screws kit (contain GB70.2-M8x16-Cr 4EA)	KIT VIS DISQUE M8x16 (lot 4)	

REAR BRAKE









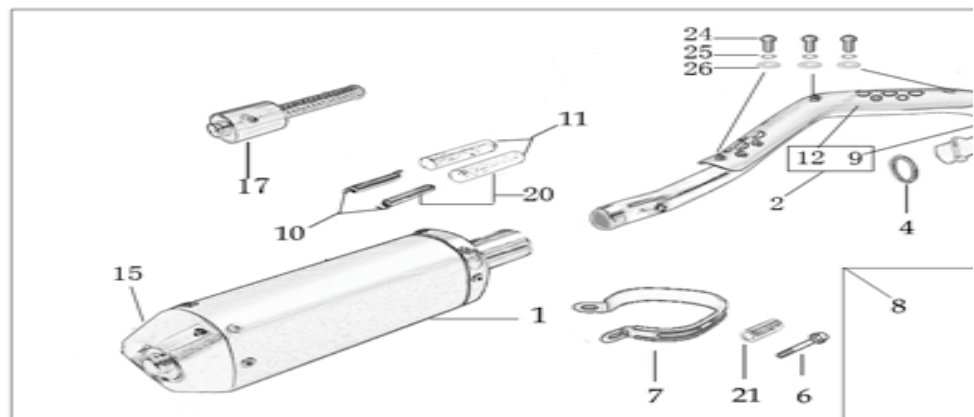











N°	Ref.	Description	Français	Picture
1	YC110-1201-04	Rear Caliper 1 pistons d10 w/t abestos	Etrier frein arrière 1 piston d10 sans amiante	
2	YC110-1201027	Rear reservoir d 10mm (with stick L=57mm)	Maitre cylindre frein arrière avec embout durite d 10mm	
3	YC110-1201049	Oil steel tube L=515mm d10/d10 BIGY 2016	Durite frein arrière L=515mm d10/d10 BIGY 2016	
4	YC110-1204	Friction pad for 1 piston brake w/t abestos with copper substrate	Plaque de frein arrière 1 piston SANS AMIANTE	
5	YC110-1205-06	Steel brake pedal	Pédale de frein ACIER	
6	YC110-21-01	Spring for Steel brake pedal' d3xd32x7mm	ressort pour pédale de frein Acier d3xd32x7mm	
9	GB882-d7x16-W	Pin shaft 7x16mm for push rod	axe 7x16mm pour fixation tige	
10	GB91-d1.6x16-W	Split pin 1.6x16mm for push rod	goupille 1.6x16mm pour fixation tige	
11	GB70-M6x20	Hex. Bolt M6x20 for rear reservoir	vis M6x20 pour maitre cylindre arriere	

14	YC110-12012-27	Rear brake aasy 1 piston W/T ABESTOS d10/d10 L=515mm 2017	Kit frein arriere 1 piston avec gaine plastic SANS AMIANTE d10/d10 L=515mm 2017	
15	YC110-1201-01	Rear brake bracket T=5MM	patte fixation étrier frein arriere T=5MM	
16	YC110-1255	Rear Brake pads Screw L=38mm	Vis plaquette AR L=38mm	
18	GB70.1-M10x35-B	Nut for brake pedal M10x35	vis pour pédale frein M10x35	
19	YC110-217-01	Steel brake pedal PILOT / SM150 2013-17	Pédale de frein Acier PILOT / SM150 2013-17	
21	YC110-120110	rubber for rear caliper	jeu de caoutchouc d'etrier frein arriere	
23	YC110-21-10	Steel brake pedal end cap	Embout pédale de frein Acier	
25	YC110-12025-01	Rubber for REAR RESERVOIR PUSH STICK 2016	Caoutchouc tige maitre cylindre frein arrier 2016	
30	GB70-M6x16-Cr	Hex. Bolt M6x16 for Steel brake pedal end cap	vis M6x16 pour Embout pédale de frein	
34	YC110-1215-06	Mount for rear break reservoir "extern" 2017	fixation maitre cylindre frein arriere "externe" 2017	
35	GB70-M6x16	Hex. Bolt M6x16 for Mount for rear break reservoir	vis M6x16 pour fixation maitre cylindre frein arriere	
36	GB93-d6	Standard spring washer d6 for Mount for rear break reservoir	ronnelle d6 pour fixation maitre cylindre frein arriere	

Exhaust system

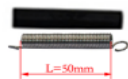







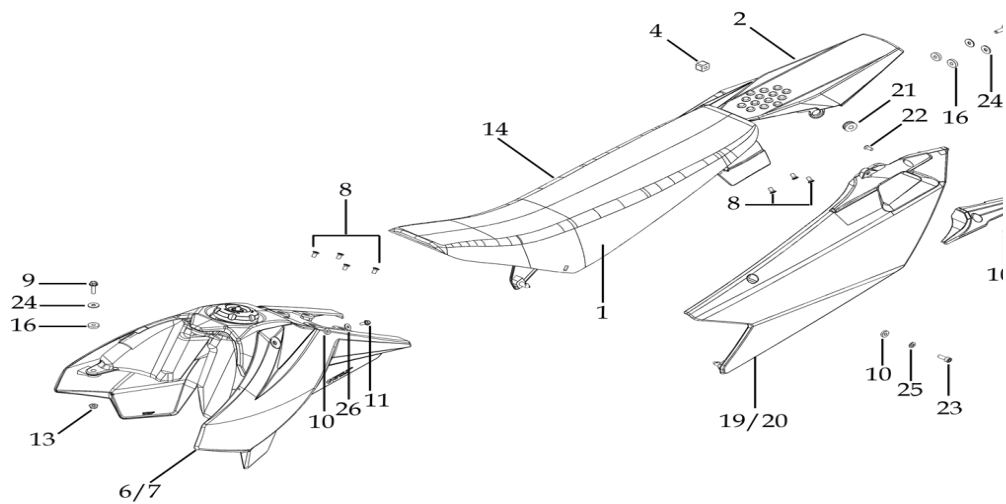

N°	Ref.	Description	Français	Picture
----	------	-------------	----------	---------

1	YC110-1301-01-GY	YCF Muffler 94db L=295mm (2 springs) GREY	Silencieux YCF 94db L=295mm (2 ressorts) GRIS	
2	YC110-1302-20	Exhaust pipe with protection plate BIGY-125Mx / 150Mx 2017	Collecteur avec plaque BIGY-125Mx / 150Mx 2017	
5	18291/152FMH	Exhaust pipe washer d32xd25.5x4	joint pot d32xd25.5x4	
6	GB6187-M6-W	Self-locking Nut M6	écrou M6	
15	GB5787-M8x20-W	Hex. Bolt with flanged M8x20 for hoop for muffler	vis M8x20 pour Attache silencieux	
7	YC110-13-04	Hoop for muffler YCF START 2011-17 (with FB13-d10xd14x23-W 1EA+GB5787-M8x40-W 1EA)	Attache silencieux YCF START 2011-17 (pas besoin entroise pour BIGY)	
8	YC110-135-02-GY	Muffler& Exhaust pipe assy YCF 94db (2 springs) BIGY125Mx / 150Mx 2017	Echappement complet YCF 94db (2 ressorts) BIGY125Mx / 150Mx 2017	
10	YC110-13-201	Muffler spring d1.2xd9x50mm	Ressort pot d1.2xd9x50mm	
11	YC110-138	YCF Rubber for muffler spring	Caoutchouc YCF ressort pot	
12	YC110-1312-02	Protection for exhaust pipe PILOT / SM150 2013	Grille pot PILOT / SM150	
24	GB70.2-M6x10-Cr	Plus screw M6x10 for exhaust protection	vis M6x10 pour grille	
25	GB93-d6-W	Standard spring washer d6 for exhaust protection	rondelle d6 pour grille	
26	GB97-d6-W	flat washer d6 for exhaust protection	rondelle d6 pour grille	
17	YC110-13-301	Noise reducer (spark arrestor) YCF START	Bride de pot YCF START	
20	YC110-13-21	YCF Muffler spring with rubber	Ressort pot avec le caoutchouc YCF	
15	YC110-13-32	Muffler end cap YCF	Emout silencieux YCF	
	GB70.2-M5x12	Plus screw M5x12for muffler end cap	vis M5x12pour Emout silencieux	
	GB93-d5	Standard spring washer d.5 for muffler end cap	rondelle d.5pour Emout silencieux	

Seat & Plastic kit







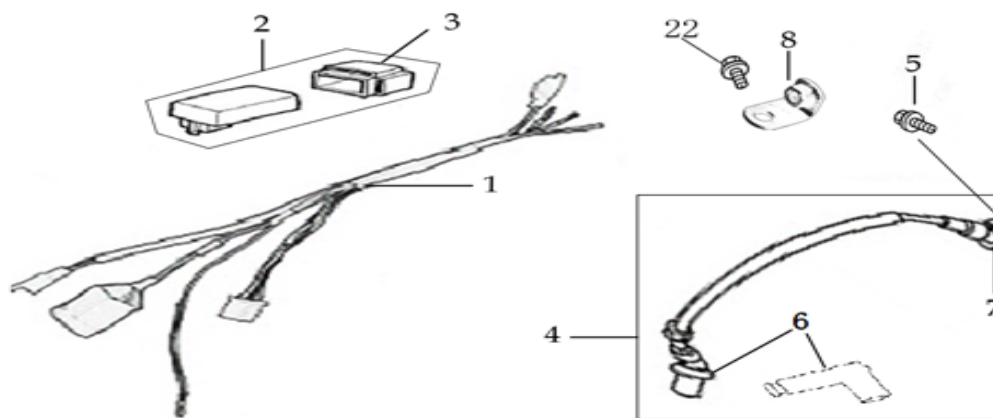

N°	Ref.	Description	Français	Picture
1	YC110-1401-11	Seat assy BIGY 2017	Selle BIGY 2017	
2	YC110-14-019-WH	Rear fender BIGY 2017 WHITE	Garde boue arrière BIGY 2017 BLANCHE	
17	YC110-1428-02-BK	Handle right side BIGY 2017 BLACK	Poignee plaque laterale droite Bigy 2017	
19	YC110-14-029-WH	right side plastic BIGY 2017 WHITE	Plaque latérale droite BIGY 2017 BLANC	
18	YC110-1429-02-BK	Handle left side BIGY 2017 BLACK	Poignee plaque laterale gauche Bigy 2017	
20	YC110-14-049-WH	Left side plastic BIGY 2017 WHITE	Plaque latérale gauche BIGY 2017 BLANC	
21	YC110-1404-01	Cushion for side plastic d8.2d20.2x9mm 2017	Caoutchouc plaque laterale d8.2d20.2x9mm 2017	
4	YC110-14-03	Cushion for right side plastic	caoutchouc plaque laterale droite	
22	GB819-M5x12-W	Plus screw M5x12 for Handles	vis m5x12 pour Poignees plaques	
23	GB70-M6x16-Cr	Hex. Bolt M6x16 for handle and No plate fixation to the frame	vis M6x16 pour fixation plaque et poignees sur cadre	
25	GB97-d6-W	flat washer d6 for handle and No plate fixation to the frame	rondelle d6 pour fixation plaque et poignees sur cadre	
10	YC110-02-13	Rubber washer d6xd14x3mm for handle and No plate fixation to the frame	joint caoutchouc d6xd14x3mm pour fixation plaque et poignees sur cadre	
6	YC110-14-058-YE	Right shroud BIGY 2017 YELLOW	ouie radiateur droite BIGY 2017 JAUNE	

7	YC110-14-068-YE	Left side shroud BIGY 2017 YELLOW	ouie radiateur gauche BIGY 2017 JAUNE	
8	GB819-M6x12-W	Plus screw M6x12 for fixation of rear fender on the seat and shrouds on the gas tank	vis m6x12 pour fixation garde boue sur selle et ouie sur reservoir	
9	GB5787-M6x25-W	hex. Bolt with flanged M6x25 for shroud fixation on gas tank front	vis M6x25 pour fixation ouis sur reservoir avant	
11	FB5787-M5x12-W	hex. Bolt with flanged M5x12 for shroud fixation on gas tank sides	vis M5x12 pour fixation ouis sur reservoir cotes	
26	GB96-d5-W	flat washer d5xd12 for shroud fixation on gas tank sides	rondelle d5xd12 pour fixation ouis sur reservoir cotes	
12	GB5787-M6x20-B	hex. Bolt with flanged M6x20 BLACK for seat fixation on subframe	vis M6x20 NOIR pour fixation selle sur boucle acier	
13	GB6177-M6-W	Hex. Flanged nut M6 for shroud fixation on gas tank front	écrou M6 pour fixation ouis sur reservoir avant	
14	YC110-1414-01	Seat cover BIGY 2017	Housse selle BIGY 2017	
16	YC110-03-01	Rubber washer d6xd18x4mm	joint caoutchouc d6xd18x4mm pour fixation ouis sur reservoir avant	
24	GB96-d6	flat washer d6 for shroud fixation on gas tank front	rondelle d6 pour fixation ouis sur reservoir avant	

ELECTRIC

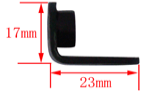

N°	Ref.	Description	Français	Picture
1	YC110-1501-09	Wire harness WATERPROOF BIGY F125Mx / 150 Mx / F150Mx 2017	Faisceaux electrique etanche Bigy 125Mx / 150Mx / F150Mx 2017	
2	YC110-1503	CDI Ignitor assy.125cc	CDI 125cc	
4	YC110-1504-07	Ignitor coil L=350mm	bobine haute tension L=350mm	
5	GB5787-M6x20-W	Hex. Bolt M6x20 for Ignitor coil fixation	vis m6x20 pour fixation bobine haute tension	

8	YC110-1506	The Ignitor coil stents BLACK	Support Bobine Noir	
22	GB5787-M6x16-W	Hex. Bolt M6x16 for Ignitor coil stents fixation	vis m6x16 pour fixation support bobine	

Frame

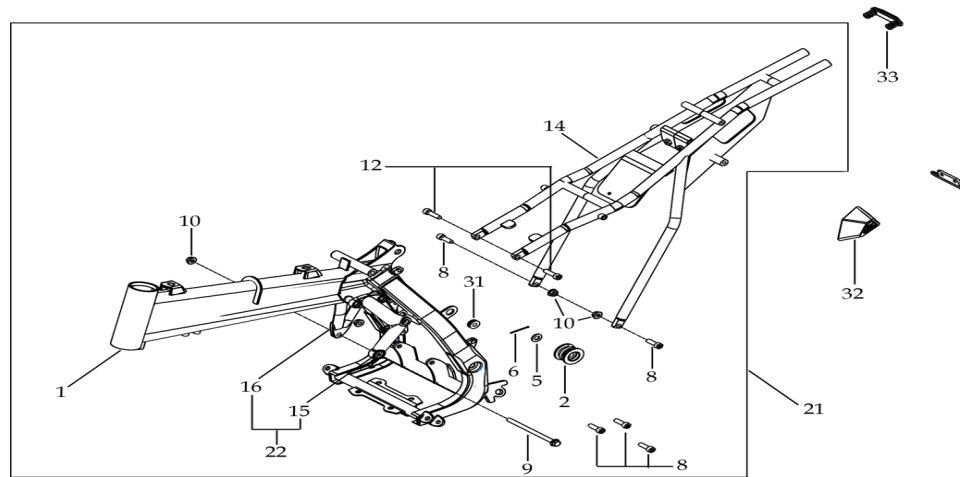







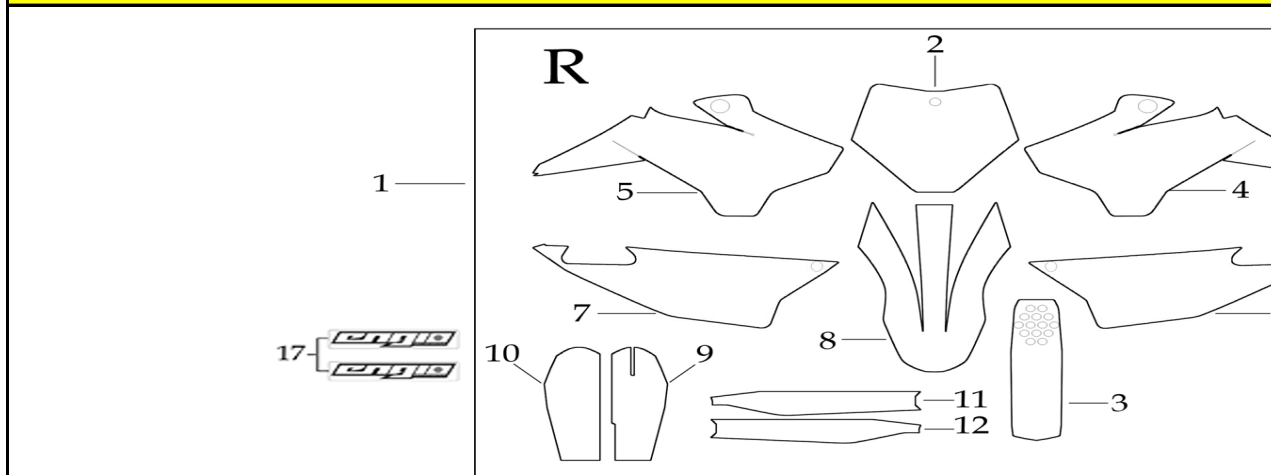





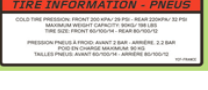

N°	Ref.	Description	Français	Picture
1	YC110-1601-04-BK	Chromoly Frame BIGY 2018 BLACK axle 15	Cadre chromolly BIGY 2018 NOIR axe 15	
2	YC110-2201	YCF Chain tensioner component	roulette chaine YCF	
5	GB97-d10-W	Flat washer d10x17x2 for Chain tensioner	rondelle d10x17x2 pour roulette chaine	
6	GB91-d2x25-W	cotter pin d2.0x25 for Chain tensioner	goupille d2.0x25 pour roulette chaine	
15	YC110-1615-03	Frame engine aluminium pads left Bigy SILVER 2017	Patte de cadre aluminium gauche Bigy 2017 SILVER	
16	YC110-1616-03	Frame engine aluminium pads right Bigy SILVER 2017	Patte de cadre aluminium droite Bigy 2017 SILVER	
8	GB5787-M8x100-W	Hex. Bolt with flanger face M8x100 for frame engine aluminium pads	vis M8x100 pour patte de cadre	
	GB96-d8-W	Washer d8xd20mm for frame engine aluminium pads	Rondelle d8xd20mm pour patte de cadre	
9	GB5787-M8x125-W	Hex. Bolt with flanger face M8x125 for frame engine aluminium pads	vis M8x125 pour patte de cadre	
10	GB6187-M8-W	Self locking nut M8 for frame engine aluminium pads	ecrou M8 pour patte de cadre	
14	YC110-1614-08-BK	REAR FRAME PART STEEL BIGY-125 2016	Boucle arriere acier Bigy 2017	
12	GB70-M8x30	Stud screw M8x30 for subframe fixation	vis M8x30 pour fixation boucle arriere	

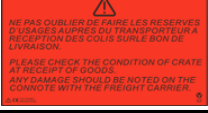

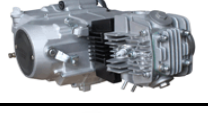

8	GB70-M8x25	Stud screw M8x25 for subframe fixation	vis M8x25 pour fixation boucle arriere	
10	GB6187-M8-W	Self locking nut M8 for subframe fixation	ecrou M8 pour fixation boucle arriere	
21	YC110-1621-02-BK	Complete frame BIGY 2018	Cadre complet BIGY 2018	
22	YC110-1622-03	Set of aluminium engine pads BIGY 2017	Jeu de patte de cadre aluminium BIGY 2017	
24	YC110-0460-01	Rear shock absorber mudflap	Bavette caoutchouc	
28	GB5787-M6x20-W	hex. Bolt with flanged M6x20 for mudflap fixation	vis M6x20 pour fixation bavette	
29	GB96-d6-W	Washer d6xd18mm for mudflap fixation	Rondelle d6xd18mm pour fixation bavette	
30	YC110-03-01	Rubber washer d6xd18x4mm for mudflap fixation	joint caoutchouc d6xd18x4mm pour fixation bavette	
31	YC110-1404-01	Rubber for Subframe	Caoutchouc pour Boucle Arriere	
32	YC110-1634-01	Cover rubber for left muffler connexion BIGY 2017	Cache Caoutchouc Connexion Silencieux Gauche Bigy 2017	
33	YC110-1633-01	YCF Rubber plug for Subframe BIGY 2017	Embout Caoutchouc YCF boucle arriere Bigy 2017	

GRAPHICS





N°	Ref.	Description	Français	Picture
1	KDBIGY12519	BIGY 125 Mx complete graphic kit 2019	Kit deco complet BIGY 125 Mx 2019	





YC110-1912	YCF Air box Sticker	Sticker Boite a Air YCF	
YC110-1901	Sticker Chain	Autocollant Chaîne	
YC110-1902	Sticker Tire	Autocollant Pression Pneu	
YC110-1903	Sticker Warning OIL Level	Autocollant Attention Niveau Huile	
YC110-1904	Sticker Rear Mudguard 70x57mm	Autocollant garde boue arriere 70x57mm	
YC110-1905	Sticker CE	Autocollant CE	
YC110-1906	Warning sticker	Sticker Attention	
YC110-1907	Warning Sticker Transport	Sticker Caisse Avertissement Transport	
YC110-1908	Warning Sticker Shok Absorber	Sticker Avertissement Amortisseur	
ENGINES			
MOTEUR125P	ENGINE 125 Yx "O" Start	MOTEUR Yx 125 Demarage en Prise	
17311-2	Inlet Pipe, Pro CP 2012	PIPE ADMISSION CP 2012	
GB70-M6x20	Hex. Bolt M6x20 for inlet pipe fixation	vis M6x20 pour fixation pipe admission	
17332	carburettor paper gasket d28	joint papier carburateur d28	
17332/152FMH01	Intake Gasket	JT PAPIER PIPE ADMISSION	
F00C039	carburettor isolating gasket d27.5	joint plastique carburateur d27.5	
11411/152FMH	Crankcase Cover, LH Yx125	CARTER ALLUMAGE	

YC140-27500SI	STEEL KICK YCF 2015-17 SMALL HOLE	KICK ACIER 2015-17 PETIT DIAMETRE SILVER	
24700/152FMH	Gearshift Pedal	SELECTEUR	
RCSC-BK	Right crankcase small Cover 88/125 BLACK	DEMI CARTER EMBRAYAGE NOIR 88/125	
GB70.2-M6x20	Plus screw M6x20 for Right crankcase small Cover	vis M6x20 pour fixation demi carter embrayage	

CARBU

CARBU26MIKUNI	MIKUNI Carburetor 26 RS/RSSA/SM125 2012 with main jet 95 and slow jet 15	Carbureteur 26 MIKUNI RS/RSSA/SM125 2012 GICLEUR 95 GICLEUR 15	
GB5787-M6x30-W	Hex. Bolt with Flanged Face M6x30 for carburetor fixation on inlet pipe	vis M6x30 pour fixation carbu sur pipe admission	
GB6170-M6-W	Hex flanged self locking nut M6 for carburetor fixation on inlet pipe	écrou M6 pour fixation carbu sur pipe admission	
GICLEUR107.5	main jet 107.5	GICLEUR 107.5	
YC110-3847-01	Carburetor spring d17x70mm	Ressort Carbu d17x70mm	

CARTONS - CAISSES MOTOS

YC110-CARTON-04	BIKE BOX BIGY 1750x380x920mm	CARTON EMBALLAGE MOTO BIGY	
YC110-FOAMBOX	Foam box 420x340x160mm	Cale PS	
YC110-FILM	Protective film for seat 600x600x0.02mm	Protection plastique de Selle	
YC110-2101-03	Silicagel	Silicagel	

CATALOGUES - FICHES MOTOS - FICHES STICKER

YC110-0700-01	Accessory tools	Trousse a outils	
YC110-0700-0201	Owner manual 2017	Manuel Utilisation 2017	
YC110-0700-0401	Vin Plate 2017	Plaque Vin 2017	

	YC110-0700-03	A4 sheet assy	Fiche A4	
--	---------------	---------------	----------	---

2019

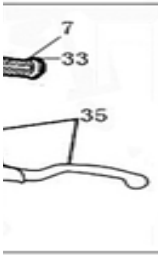

Qty/Bike	Model
1	BIGY1251719/1501719
1	ALL BIKES 1219
1	P1251419/P1501419/S M1501419/SP11416/SP 21419/SP31419/BIGY17 19
1	ALL BIKES 1219
1	ALL BIKES 1219
1	ALL BIKES 1219
1	ALL BIKES 1219
1	ALLBIKES 1819 (125L1819/50A)
1	ALL BIKES (BUT 50A)

1	ALL BIKES 1819 (BUT 125L1819/50A)
1	F88s1217/F88se1519/F88L1819/F125L1719/F1251219/F125s1219/F125se1519/P88s1315/P1251319/P1501219/SM125s1219/BIGY1251719/1501719
1	BIGY 19 (BUT 190C)
1	ALL BIKES 1219 (BUT50/F88s/F88se)
1	ALL BIKES 1719 (BUT50E)
2	ALL BIKES 1219 (BUT50A)
2	ALL BIKES 1219 (BUT50A)
1	ALL BIKES 1819 (BUT 125L1819/50A)
1	ALL BIKES 1819 (BUT 125L1819/50A)
1	ALL BIKES (BUT 50A)
1	ALL BIKES (BUT 50A)
2	ALL BIKES
2	ALL BIKES
5	ALL BIKES
1	ALL BIKES
1	BIGY1251719
1	ALL BIKES 1219

1	ALL BIKES 1219
1	ALL BIKES 1219
1	ALL BIKES 1219
2	ALL BIKES 1219
1	F88s1819/F88se1819/F125L1819/F1251819/F125s1819/F125se1819/P88s1819/P1251819/P1501819/SM125s1819
1	F88s1819/F88se1819/F125L1819/F1251819/F125s1819/F125se1819/P88s1819/P1251819/P1501819/SM125s1819/BI GY1251819/1501819
1	BIGY1251819/1501819
1	ALL BIKES 1219
1	SP21819/SP31819/BIGY F1501819/BIGY FD190Mx1819/BIGYZE1 90Mx1819
1	SP21819/SP31819/BIGY F1501819/BIGY FD190Mx1819/BIGYZE1 90Mx1819
1	SP21819/SP31819/BIGY F1501819/BIGYFD190M x1819/BIGYZE190Mx18 19
	SP21819/SP31819/BIGY F1501819/BIGYFD190M x1819/BIGYZE190Mx18 19
1	P1251619/P1501419/S M1501419/SP1419/BIG Y1719

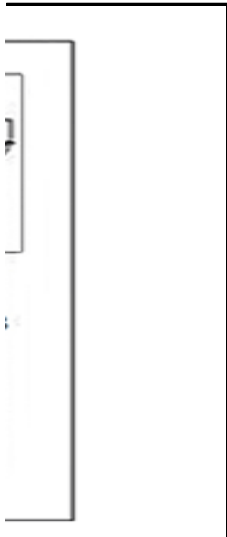

Qty/Bike	MODEL
1	ALL BIKES 1219 (BUT50A/F88s/F88se)
1	F88s1419/F88se1519/F1251419/F125s1419/F125se1519/SM125s1419/SM1501519/SP11416/BIGY1251719/1501719
1	F88s1419/F88se1519/F1251419/F125s1419/F125se1519/SM125s1419/SM1501519/SP11416/BIGY1251719/1501719
2	ALL BIKES 1315/ALL BIKES 1619 (BUTF125L/SP3)
2	ALL BIKES 1219 (BUT50A/F125L/SP)
1	BIGY12519
1	ALL BIKES 1219 (BUT50A/F88s/F88se)
1	ALL BIKES 1219 (BUT50A/F88s/F88se)
1	ALL BIKES 1219
3	ALL BIKES 1219
1	ALL BIKES 1219
1	ALL BIKES 1419 (BUT50A/F88s/F88se/P88s)

4	ALL BIKES 1219 (BUT50A/SP3/BIGY190C)
8	ALL BIKES 1219 (BUT50A)
4	ALL BIKES 1219 (BUT50A)
4	ALL BIKES 1219
1	ALL BIKES 1219
2	ALL BIKES 1219
1	ALL BIKES 1419 (BUT50A/F88s/F88se/P 88s)
1	ALL BIKES 1219
1	ALL BIKES 1219
1	F1251419/F125s1419/F 125se1519/SM125s141 9/SM1501519/BIGY125 1719/1501719
1	ALL BIKES 1219 (BUT50A/SP1/SP2/SP3)
1	ALL BIKES 1419 (BUT50A/F88s/F88se/P 88s)
1	ALL BIKES 1419 (BUT50A/F88s/F88se/P 88s)
1	ALL BIKES 1419 (BUT50A/F88s/F88se/P 88s)
1	ALL BIKES 1419 (BUT50A/F88s/F88se)

Qty/Bike	MODEL
1	BIGY12519
3	ALL BIKES

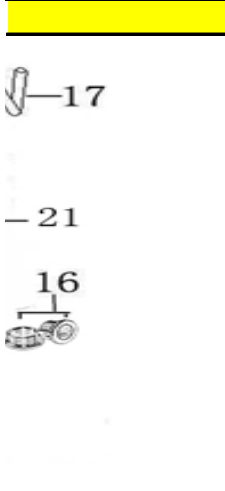

Qty/Bike	MODEL
1	BIGY1251719/1501719
1	BIGY1251719/1501719
1	BIGY1251719/1501719
1	P1251619/P1501619/S M1501619/SP1619/BIG Y 1719
1	P88s1315/P1251319/P1 501319/SM1501319/SP 1319/BIGY1719
1	BIGY1251719/1501719
2	ALL BIKES 1219 (BUT50A)
1	P1251619/P1501619/S M1501619/SP1619/BIG Y1719
6	P12519/P15019/SP2-3- 19/SM15019/BIGY19
2	ALL BIKES (BUT 50A- E/F88L/125L/SP1-2- 3/BIGYF150/BIGY190FD /BIGY190ZE)

2	ALL BIKES (BUT 50A-E/F88L/125L/SP1-2-3/BIGY150/BIGY190FD/BIGY190ZE)
1	P1251619/P1501619/SM1501619/SP1619/BIGY1719
1	ALL BIKES 1219 (BUT 50A)
2	ALL BIKES 1319 (BUT50A)
2	ALL BIKES (BUT 50A-E)
1	BIGY1251719/1501719
2	BIGY1251719/1501719
2	BIGY1251719/1501719

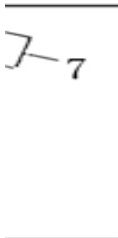
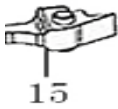

Qty/ Bike	MODEL
1	P1251619/P1501619/SP1619/SM1501619/BIGY1719
1	ALL BIKES 1219 (BUT 50A/F88s/F88se/F88L/F125L)
1	ALL BIKES 19 (BUT50A)

1	SP31619/BIGY1719
1	ALL BIKES 1219 (BUT50A)
2	ALLBIKES 1215 (BUT50A/F88s/F88se)/F1251619/F125s1619/F125se1619/P1251619/P1501619/SP116/SM1619/BIGY1251719/1501719
2	ALL BIKES 1219 (BUT50A)
1	ALL BIKES 1219 (BUT50A)
1	ALL BIKES 1219 (BUT50A)
1	ALL BIKES 1215 (BUT50A/F88s/F88se)/F1251619/F125s1619/F125se1619/P1251619/P1501619/SP11416/SM1619/BIGY1251719/1501719
1	BIGY1251719/1501719
2	ALL BIKES 1219 (BUT50A)
2	ALL BIKES 1219 (BUT50A/F88s/F88se)
1	ALL BIKES 19 (BUT50A)



Qty/ Bike	MODEL
-----------	-------

1	BIGY1251719/1501719
1	BIGY1251719/1501719
1	BIGY1719
1	ALL BIKES
1	BIGY1251719/1501719
1	ALL BIKES1315(BUT50A)/ALL BIKES1619(BUT50A/SP2 /SP3)
2	ALL BIKES1315(BUT50A)/ALL BIKES1619(BUT50A/SP2 /SP3)
1	ALL BIKES15(BUT50A)/ALL BIKES1619(BUT50A/SP2 /SP3)
1	ALL BIKES1215(BUT50A)/ALL BIKES1619(BUT50A/SP2 /SP3)
1	BIGY1719
1	ALLBIKES1319 (BUT50A/SM)
1	ALL BIKES 1619 (BUT50A/F88s/F88se)
4	ALL BIKES1619 (BUT50A)
1	ALL BIKES1619 (BUT50A)
1	BIGY1251719/1501719
1	BIGY1719
2	ALL BIKES139(BUT50A)

1	SP116/BIGY1251719/1501719
1	ALL BIKES



Qty/Bike	MODEL
1	BIGY1719
2	ALL BIKES 1119
2	ALL BIKES 1119
1	ALL BIKES 1119
1	ALL BIKES
1	ALL BIKES
1	ALL BIKES
1	ALL BIKES
2	ALL BIKES 1219
2	ALL BIKES (BUT F88L/F125L)
1	ALL BIKES

1	ALL BIKES
1	ALL BIKES
2	ALL BIKES
1	ALL BIKES 1319
1	ALL BIKE 1319 (BUT50A)
1	BIGY 1719
1	BIGY 1719
2	BIGY 1819
2	BIGY 1819
1	BIGY 1719



Qty/Bike	MODEL
1	SP11316/SP21319/SP31319/BIGY1719
1	ALL BIKES1219 (BUT50A)
1	SP2A1819/SP3A1819/BIGY201819

1	P1251619/P1501619/SP1319/SM1501619/BIGY1719
1	P1251619/P1501619/SP1319/SM1501619/BIGY1719
1	SP11516/SP21519/SP315/BIGY1719(BUT190C)
1	SP1219/BIGY1719
1	SP1219/BIGY1719
3	SP1219/BIGY1719
4	SP1219/BIGY1719
1	SP11216/SP21219/SP31501215/BIGY1719(BUT190C)
1	SP1219/BIGY1719
1	SP1219/BIGY1719
1	SP1219/BIGY1719
1	BIGY1719
2	SP1219/BIGY1719
2	SP1219/BIGY1719
1	P1251619/P1501619/SP1319/SM1501619/BIGY1719

Qty/Bike	Model
1	F88s1319/F88se1519/F88L1619/F125L1619/F1251319/F125s1319/F125se1519/P88s1315/P1251319/P1501319/SM1319/BIGY12517/1501719
1	F88s1319/F88se1519/F88L1619/F125L1619/F1251319/F125s1319/F125se1519/P88s1315/P1251319/P1501319/SM1319/BIGY12517/1501719
1	ALL BIKES 1319 (BUTSP1/SP2/SP3)
1	ALL BIKES1319(BUTSP1/SP2/SP3)
2	ALL BIKES1419 (BUT50A/50E/SP1/SP2/SP3)
2	ALL BIKES 1119
2	ALL BIKES 1319
1	BIGY 1719
1	ALL BIKES 1419 (BUTSP1/SP2/SP3)
1	ALL BIKES 1419 (BUTSP1/SP2/SP3)
1	ALL BIKES 1419 (BUTSP1/SP2/SP3)
1	ALL BIKES 1419 (BUTSP1/SP2/SP3)
1	BIGY125Mx1719

2	ALL BIKES 1219
1	F88s1319/F88se1519/F88L1619/F125L1619/F1251319/F125s1319/F125se1519/P88s1315/P1251319/P1501319/SM1319/BIGY12517/1501719

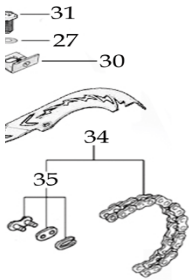

Qty/Bike	Model
1	BIGY12519/1501819
2	BIGY12519/1501819
1	BIGY1251719/1501719
2	BIGY12519/1501819
2	ALL BIKES 1219 (BUT50A)
2	ALL BIKES 1219 (BUT50A)
2	F88s1219/F88se1519/F1251219/F125s1219/F125se1519/P88s1315/P1251319/P1501319/SM1219/SP116/BIGY1251719/1501719
1	P1251519/P1501519/SP1219/SM1501519/BIGY1719
1	ALL BIKES1215(BUTSP1/SP2/SP3)/ ALL BIKES1619(BUTSP2/SP3)
5	ALL BIKES 1519 (BUTSP2/SP3)

5	ALL BIKES 1519(BUTSP2/SP3)
1	P1251819/P1501819/S M1819/BIGY1819
1	P1251819/P1501819/S M1819/BIGY1819
1	F88s1319/F88se1519/F 1251319/F125s1319/F1 25se1519/P88s1315/P1 251319/P1501319/SP11 6/BIGY12517/1501719
1	ALL BIKES 1219 (BUT50A)
1	P1251519/P1501519/SP 1219/SP21219/SP31218 /SM1501519/BIGY1719(BUT BIGYFD190MX19)
1	P1251519/P1501519/SP 1219/SM1501519/BIGY 1719
1	P1251519/P1501519/SP 1219/SM1501519/BIGY 1719
1	P1251519/P1501519/SP 1219/SM1501519/BIGY 1719
1	P1251519/P1501519/SP 1216/SM1501519/BIGY 1719
1	P1251519/P1501519/SP 1216/SM1501519/BIGY 1719
1	P1251519/P1501519/SP 1216/SM1501519/BIGY 1719
2	P1251519/P1501519/SP 1216/SM1501519/BIGY 1719
2	P1251519/P1501519/SP 1216/SM1501519/BIGY 1719
1	P1251519/P1501519/SP 1216/SM1501519/BIGY 1719
1	ALL BIKES 1219 (BUT50A)
1	ALL BIKES 1219(BUT50A)
1	ALL BIKES 1219(BUT50A)
3	ALL BIKES 1219
1	SP1216/SP21219/SP312 18/BIGY1719(BUT BIGY190MX1718)

2	SP1216/BIGY1719
1	BIGY1251719/1501719
1	ALL BIKES (BUT50E)
1	ALL BIKES 19 (BUT50A)
3	ALL BIKES 19 (BUT50A)
2	ALL BIKES 19 (BUT50A)

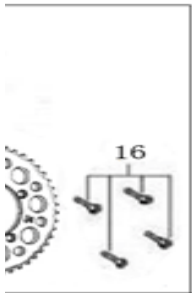
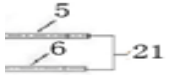

Qty/Bike	Model
1	BIGY1251719/1501719
1	BIGY1251719/1501719
1	BIGY1719
1	ALL BIKES

1	BIGY1251719/1501719
1	BIGY1251719/1501719
1	SP116/BIGY1251719/1501719
1	F881319/F1251319/P1251319/SP11316/SM1319/BIGY1719
2	ALL BIKES 1215(BUT50A)/ALL BIKES 1619 (BUT50A/SP2/SP3)
2	ALL BIKES 1319 (BUT50A)
1	BIGY125Mx1719/150Mx1719
1	F88s1219/F88se1519/F125L1619/F1251219/F125s1219/F125se1519/P88s1215/P1251319/P1501319/SM1219/SP116/BIGY1251719/1501719
1	F88s1219/F88se1519/F125L1619/F1251219/F125s1219/F125se1519/P88s1215/P1251319/P1501319/SM1219/SP116/BIGY1251719/1501719
1	SP1619/BIGY1251719/1501719
5	SP1619/BIGY1251719/1501719
5	SP1215/BIGY1719
5	SP1215/BIGY1719
1	ALL BIKES 1619 (BUT50A)
4	ALL BIKES 1619 (BUT50A)
1	BIGY1719

1	SP1619/BIGY1251719/1501719
1	ALL BIKES



Qty/Bike	Model
1	ALL BIKES 1215 (BUT50A)/ALL BIKES 1619 (BUT50A/SP2/SP3)
1	BIGY1251719/1501719
1	BIGY1251719/1501719
2	ALL BIKES 1215(BUT50A/F88s/F88se)/ALL BIKES 1619 (BUT50A/F88s/F88se/F125L/SP2/SP3)
1	P88s1315/P1251319/P1501319/SM1501319/BIGY1251719/1501719
1	ALL BIKES 1314 (BUT50A)/ALL BIKES 1519 (BUT50A/SP1/SP2/SP3)
1	ALL BIKES 1219 (BUT50A)
1	ALL BIKES 1219 (BUT50A)
2	ALL BIKES 1219 (BUT50A)

1	BIGY1251719/BIGY1501719
1	ALL BIKES1215(BUT50A)/ALL BIKES1619(BUT50A/SP2/SP3)
2	ALL BIKES1215(BUT50A)/ALL BIKES1619(BUT50A/SP2/SP3)
1	P88s1315/P1251319/P1501319/SM1501319/SP1319/BIGY1251719/BIGY1501719
1	P88s1315/P1251319/P1501319/SM1501319/BIGY1251719/1501719
1	ALLBIKES1215(BUT50A)/F88s1619/F88se1619/F125L1619/F125s1619/F125s1619/F125se1619/SM125s1619/BIGY1251719/1501719
1	F88s1219/F88se1519/F125L1619/F125s1219/F125s1219/F125se1519/P88s1215/P1251319/P1501319/SM1219/BIGY12517/1501719
1	P1251619/P1501619/SP16/SM1501619/BIGY1719
2	F88s1319/F88se1519/F125L1619/F125s1319/F125s1319/F125se1519/P88s1315/P1251319/P1501319/SM1319/BIGY12517/1501719
1	BIGY1251719/1501719
2	P88s1315/P1251319/P1501319/SM1501319/SP1319/BIGY1719
4	SP1319/BIGY1719

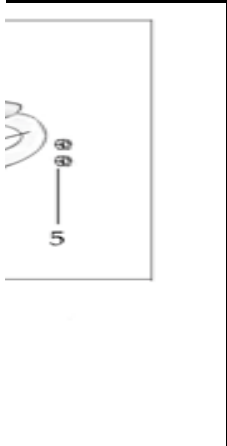

Qty/BI ke	Model
--------------	-------

1	SP11516/BIGY1251719/ 1501719
1	BIGY1251719/1501719
1	ALL BIKES1219(BUT50A)
2	BIGY1719
1	BIGY1719
1	F88s1219/F88se1519/F 125L1619/F1251219/F1 25s1219/F125se1519/P 88s1215/P1251319/P15 01219/SP11216/SM121 9/BIGY1251719/BIGY15
1	BIGY1251719/1501719
1	ALL BIKES1214(BUT50A)/AL L BIKES1519(BUT50A/SP)
2	ALL BIKES1219 (BUT50A)
1	P88s1315/P1251319/P1 501319/SM1501319/BI GY125Mx1719/150Mx1 719/F150Mx1719
4	ALL BIKES 1319
4	ALL BIKES 1319
4	ALL BIKES 1319
1	F88s1216/F88se1519/F 88L1719/F125L1619/F1 50L1719/F1251216/F12 5s1219/F125se1519/P8 8s1215/P1251319/P150
1	ALL BIKES 1214 (BUT50A)/ALL BIKES 1219 (BUT50A/SP2/SP3)
1	F88s1219/F88se1519/F 88L1619/F125L1619/F1 251219/F125s1219/F12 5se1519/P88s1215/P12 51319/P1501219/SP114 16/SM1219/BIGY12517 19
3	F88s1219/F88se1519/F 88L1619/F125L1619/F1 251219/F125s1219/F12 5se1519/P88s1215/P12 51319/P1501219/SP114 16/SM1219/BIGY12517 19
3	88L1619/F125L1619/F1 251219/F125s1219/F12 5se1519/P88s1215/P12 51319/P1501219/SP114 16/SM1219/BIGY12517 19

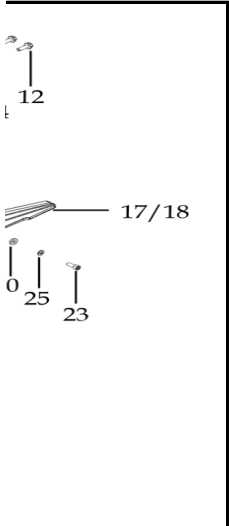

Qty/Bike	Model
1	BIGY 1719
	BIGY1251819
1	BIGY 1719
1	BIGY1251719/1501719/ 150B1719
1	BIGY 1719
1	BIGY1251719/1501719/ 150B1719
2	P1251619/P1501619/S M1501619/SP1619/BIG Y1719
1	ALL BIKES
2	P1251619/P1501619/S M1501619/SP1619/BIG Y1719
4	BIGY 1719
4	P1251619/P1501619/S M1501619/SP1619/BIG Y1719
6	ALL BIKES 1219
1	BIGY1251719/1501719/ 150B1719

1	BIGY1251719/1501719/ 150B1719
7	BIGY 1719
2	BIGY 1719
2	ALL BIKES 1219
2	ALL BIKES 1219
2	ALL BIKES 1219
2	ALL BIKES 1219
1	BIGY 1719
4	ALL BIKES 1219
4	ALL BIKES 1219



Qty/Bike	Model
1	BIGY1251719/1501719/ 150B1719
1	ALL BIKES (BUT 50A/SP3/BIGYF190FD)
1	BIGY1251719/1501719/ 150B1719
1	ALL BIKES1319(BUT50A/SP3)

1	SP11316/SP21319/BIGY 1719(BUT190C)
1	ALL BIKES 1219





Qty/Bike	Model
1	BIGY1819
1	ALL BIKES 1119 (BUT50A)
1	ALL BIKES 1119 (BUT50A)
1	ALL BIKES 1119 (BUT50A)
1	BIGY1719
1	BIGY1719
2	BIGY1719
4	SP1319/BIGY1719
1	BIGY19
3	BIGY1719
1	BIGY1251719/1501719/150B1719/190C1719
2	BIGY1719

2	BIGY1719
2	BIGY1719
1	BIGY1819
1	BIGY1719
1	SP161719/BIGY1719
2	BIGY1719
2	SP1319/BIGY1719
2	ALL BIKES 1219
2	P1251619/P1501619/S M1501619/SP1619/BIG Y1719
1	BIGY1719
1	BIGY1719



L

6

Qty/Bike	Model
1	BIGY12519

1	SP1319/BIGY1719
1	ALL BIKES1319
1	ALL BIKES1319
1	ALL BIKES1319
1	ALL BIKES1319
1	ALL BIKES1319
1	ALL BIKES1319
1	ALL BIKES1319
1	ALL BIKES1319
1	ALL BIKES1319
1	ALL BIKES1319
1	ALL BIKES1319
1	F1251319/P1251319/BIGY1251719
1	SP11216/SP21219/BIGY1719(BUT190C)
2	BIKES1219
1	ALL BIKES201519 (BUT50A/SP3190)/BIGY1719(BUT190C)
1	ALL BIKES1519(BUT50A/SP3190)/BIGY1719(BUT190C)
1	ALL BIKES1519(BUT50A/SP3190)/BIGY1719(BUT190C)
1	ALL BIKES1519 (BUT50A/SP3190)

1	P88s1516/P1251519/BI GY1251719
1	F88se1519/F1251319/F 125se1519/P1251319/P 1501319/SM1501319/S P11316/SP21319/SP313 15/BIGY1251719/15017 19/1501719
1	50A/F88s1416/F88se15 19/F88L1719/F125L161 9/F1251416/F125s1419 /F125se19/P88s1415/P 1251419/SM125s1419/ BIGY1251719
2	SP1219/BIGY1719
1	F1251319/F125s1319/F 125se1519/P1251319/S M125s1319/BIGY12517 19
2	ALL BIKES 1219
2	ALL BIKES
1	P1251619/BIGY1251719
1	F1251319/F125s1319/F 125se1519/P1251319/P 1501319/SP11316/SP21 319/SP31501315/SM13 19/BIGY1251719/15017 19/1501719
1	BIGY1719
1	ALL BIKES 1419
1	ALL BIKES 1419
7	ALL BIKES
1	ALL BIKES
1	ALL BIKES 1319
1	ALL BIKES 1319

1	ALL BIKES
---	-----------