



YCF-Riding.com

YCF50A

2018





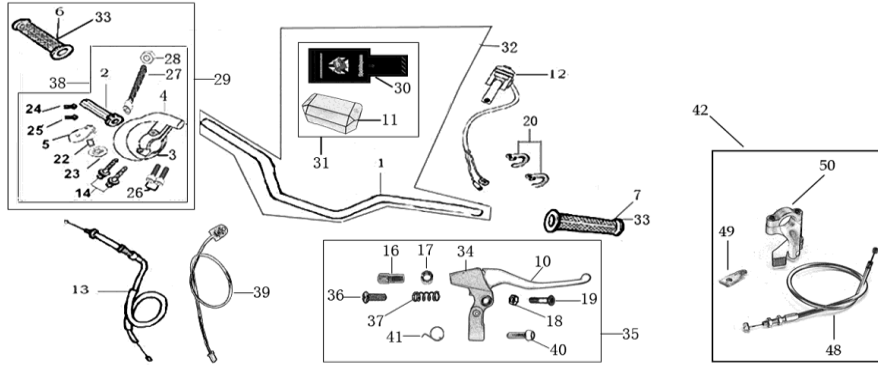





Handle bar assembly







N°	Ref.	Description	Français	Qty/ Bike	MODEL	
1	YC50-0101-01	Handle Bar YCF50 Chromelly L=570mm STEEL	Guidon YCF50 chromolly L=570mm	1	50A12-17	
2	YC110-01021-01	YCF Throttle Body 2012 BLACK	plastique poignée de gaz YCF 2012 NOIR	1	ALL BIKES 2012-2017	
3	YC110-01021-04	YCF Lower Throttle Body Housing 2012	dessous poignée gaz YCF 2012	1	50A12-17/F88L17/F88s12-17/F88se1617/F125L1617/F150L17/F12512-17/F125s12-17/F125se1617/F88s12-15/P12514-17/SM125s14-17	
4	YC110-01021-03	Upper Throttle Body Housing YCF 2012	dessus poignée gaz YCF 2012	1	ALL BIKES 2012-2017	
5	YC110-01021-02	Upper Throttle Body Housing Cover YCF 2012	plastique du dessus poignée gaz YCF 2012	1	ALL BIKES 2012-2017	
6	YC110-01-01-GY	YCF Right Grip GREY	poignée caoutchouc droite YCF GRISE	1	ALL BIKES 2012-2017	
7	YC110-01-02-GY	YCF Left Grip GREY	poignée caoutchouc gauche YCF GRISE	1	ALL BIKES 2012-2017	
10	YC50-0502-02	YCF50 Rear Brake lever (left side) L=128MM	Levier frein arriere (levier gauche) YCF50 L=128MM	1	50A12-17	
41	YC50-1206	Spring for rear brake bracket M14x17	Ressort pour frein arriere M14x17	1	50A12-17	
11	YC50-0110-01	Bar pad for Handlebar YCF50 126x75x45mm	Mousse guidon pour Guidon YCF50 126x75x45mm	1	50A12-17	
12	YC110-0105-03	YCF50 Kill Switch ON/OFF L=500MM	Coupe circuit on off YCF50 L=500MM	1	50A11-17	

13	YC50-0106-02	YCF50 Throttle Cable L=530mm A+B=125 2015	Cable gaz YCF50 L=530mm A+B=125 2015	1	50A15-17	
	YC110-0143-01	RUBBER ON THROTTLE CABLE		1	ALL BIKES2017 (BUT50E)	
16	YC50-0116	Adjust bolt M10×15mm	vis cocotte frein M10×15mm	1	50A12-17	
17	YC50-0117	YCF50 Tight Nut M10	Ecrou cocotte frein YCF50 M10	1	50A12-17	
18	FB02-M5×18	YCF50 Stepped bolt M5X18	Vis YCF50 M5X18	1	50A12-17	
19	GB6189-M5	Self-lock Nut M5	ecrou M5	1	50A12-17	
20	YC110-01-03-BK	Tape 150mm BLACK	colier maintien cable 150mm NOIR	2	ALL BIKES	
20	YC110-01-03-WH	Tape 150mm WHITE	colier maintien cable 150mm BLANC	2	ALL BIKES	
20	YC110-01-05-BK	Tape 350mm BLACK	colier maintien cable 350mm NOIR	5	ALL BIKES	
22	YC110-0102-08	YCF Throttle cable Bearing Φ8×Φ16×5mm	Roulement poignee gas YCF Φ8×Φ16×5mm	1	ALL BIKES2012-2017	
23	YC110-0102-07	YCF Throttle cable guide pulley plastic Φ12×Φ16×Φ28×8mm	Roulette plastique Poignee Gas YCF Φ12×Φ16×Φ28×8mm	1	ALL BIKES2012-2017	
24	GB819-M4×12	Plus screw M4×12	vis M4×12	1	ALL BIKES2012-2017	
25	GB819-M4×20	Plus screw M4×20	vis M4×20	1	ALL BIKES2012-2017	
26	GB70-M6×20-B	Hex. Bolt M6×20 BLACK	vis M6×20 NOIR	2	ALL BIKES2012-2017	
27	GB70-M5×50	Hex. Bolt M5×50 To adjust YCF Throttle assy	vis M5×50 Pour réglage poigne de gas YCF	1	50A12-17	
28	GB6170-M5-W	Nut M5	ecrou M5	1	50A12-17	
30	YC50-0130-02	PVC for Bar Pad YCF50 89×243mm 2018 BLACK/WHITE	PVC mousse guidon YCF50 89×243mm 2018 NOIR	1	NEW 2018 50A18	
31	YC110-0131-01	Complete Bar Pad for Handlebar without Bar L=126mm YCF50 2018 BLACK/WHITE	Mousse guidon complete pour guidon Aluminium sans Barre YCF50 2018 L=126mm NOIR	1	NEW 2018 50A18	
32	YC110-0132-02	Handle Bar Chromelley (with bar pad and pvc) YCF50 2018 BLACK/ WHITE	Guidon Chromolly complet avec mousse et pvc YCF50 2018	1	NEW 2018 50A18	
33	PPC010-GY	YCF set of grip GREY	Paire de poignée caoutchouc YCF GRISE	1	ALL BIKES2012-2017	
34	YC50-0502-01	YCF50 Rear (left side) brake bracket YCF50	Cocotte frein arriere YCF50 (cote gauche)	1	50A12-17	
35	YC50-01031	YCF50 Complete rear brake assy	Levier frein arriere complet YCF50 avec cocotte	1	50A12-17	

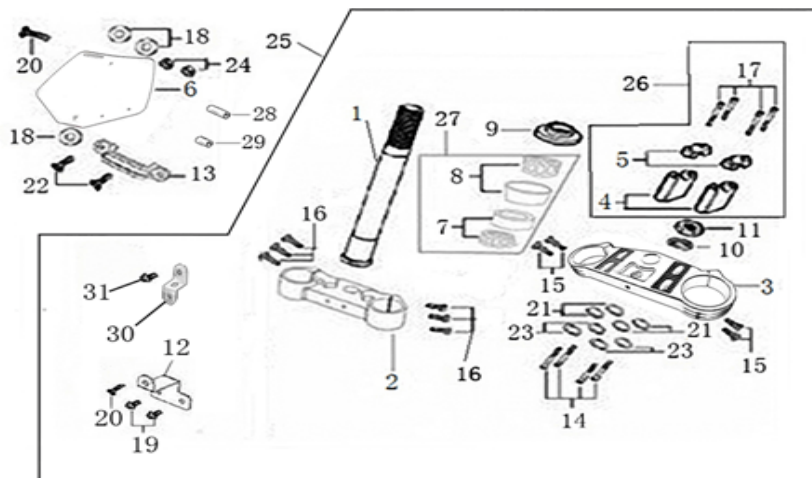





36	GB818-M4x15	Screw M4x15	Vis M4x15	1	50A12-17	
37	YC50-0136	Spring M4x15 to adjust rear brake lever	Ressort M4x15 pour réglage frein arriere	1	50A12-17	
40	GB70.2-M6x16	Screw M6x16	Vis M6x16	1	50A12-17	
38	YC50-01021-N	YCF Throttle Assy. 50CC 2012 without grip (with YC110-0102-08 1EA+GB6170-M5 1EA)	Poignee gaz réglable YCF 50CC 2012 nue	1	50A12-17	
39	YC50-0105-01	YCF50 Start switch L=500mm	Bouton demareur YCF50 L=500mm	1	50A12-17/F88se15-16/F125se15-16	
42	YC50-0142-01	Air door assembly L=440mm A+B=50mm	Starter au Guidon Complet	1	50A1617	
48	YC50-0148-01	Air door wire L=440mm A+B=50mm	Cable pour Starter au Guidon	1	50A1617	
49	YC50-0149-01	Support of Air door wire steel	Plaque Acier pour Starter au Guidon	1	50A1617	
50	YC50-0150-01	Air door bracket assembly 50A	Starter au Guidon (Partie plastique)	1	50A1617	

Steering stem assembly

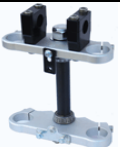
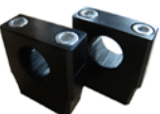





N	Ref.	Description	Français	Qty/ Bike	MODEL	
1	YC50-0200-01	Steering stem 195 mm	tige colonne direction 195 mm	1	50A12-17/F88L17/F125L1617/F150L17	
2	YC50-0202-05-GY	Lower triple clamp YCF50 135mm 2014 GREY	té fourche inferieur YCF50 135mm GRIS	1	50A14-17	
3	YC50-0201-05-GY	Top Triple Clamp YCF50 135mm 2014 GREY	té fourche supérieur YCF50 135 mm GRIS	1	50A14-17	
4	YC50-0203-04	YCF50 Lower Bar Mount CNC 35 mm BLACK	Pontet guidon inférieur YCF50 35mm NOIR	2	50A12-17	

5	YC110-0202-04	Top Bar Mout CNC Φ 22.2 mm/height 18mm START Type BLACK	pontet guidon supérieur Φ 22.2 mm Type START NOIR	2	ALL BIKES2013-17 (BUTSP3/BIGYFD190MX)	
6	YC50-0212-02-WH	YCF Front Number Plate 50cc WHITE	plaque avant BLANCHE YCF 50cc	1	NEW 2018 50A18	
7	297-41/24	Lower Taper roller bearing 41/24	roulement inférieur 41/24	1	50A12-17/F88L17/F88s13-17/F88se15-17/F125L1617/F150L17	
8	297-41/22.5	Top Taper roller bearing 41/22.5 R START 08	roulement supérieur 41/22.5	1	50A12-17/F88L17/F88s13-17/F88se15-17/F125L1617/F150L17	
9	YC110-02-09	Top nut for steering ϕ 52	écrou crantellé colonne direction ϕ 52	1	ALL BIKES2012-2017	
10	YC110-02-10	Washer for steering stem nut Φ 22.5 \times Φ 36 \times 0.7	joint colonne direction Φ 22.5 \times Φ 36 \times 0.7	3	ALL BIKES2012-2017	
11	YC110-02-11	Nut for steering stem M22	écrou supérieur colnne direction M22	1	ALL BIKES2012-2017	
12	YC110-0213-02	Number plate bracket short L=60mm H=33mm	support plaque avant courte L=60mm H=33mm	1	50A12-17/8810-12	
13	YC110-02-14-WH	Break Line Retainer White	guide durite sur plaque avant Blanc	1	ALL BIKES2012-2013/50A14-17/F88L17/F88s14-16/F88se15-17/P88s1415/F125L16/F88L17	
14	GB70-M8 \times 20	Stud screw M8X20	vis M8X20	4	50A12-17	
15	GB70-M8 \times 20	Stud screw M8X20	vis M8X20	2	50A12-17	
16	GB70-M8 \times 25	Stud screw M8X25	vis M8X25	2	50A12-17	
17	GB70-M8 \times 20	Stud screw M8X20	vis M8X20	4	50A12-17	
18	GB97- Φ 6-W	flat washer ϕ 6	rondelle ϕ 6	1	ALL BIKES 2012-17	
19	GB5787-M6 \times 16-W	Hex. Bolt with Flanged Face M6X16	vis M6X16	2	ALL BIKES2012-2017	
20	GB9074.5-M6 \times 16-W	Plus screw M6X16 (for bottom front No plate)	vis m6x16 bas plaque No avant	1	50A14-17/F88s14-16/F88se15-17/P88s1415/F125L16	
20	GB9074.5-M6 \times 25-W	Plus screw M6X25 (for top front No plate)	vis m6x25 haute plaque No avant	1	50A14-17/F88s14-16/F88se15-17/P88s1415/F125L16	
21	GB97- Φ 4-W	flat washer ϕ 4	rondelle ϕ 4	1	ALL BIKES2012-17	
22	GB818-M4 \times 10-W	Plus screw M4 \times 10	vis M4 \times 10	1	ALL BIKES2012-17	
23	GB93- Φ 8-W	Spring washer Φ 8mm	rondelle Φ 8mm	4	ALL BIKES2012-17	
24	GB6170-M4-W	Nut M4	ecrou M4	2	50A14-17/F88s14-16/F88se15-17/P88s1415	

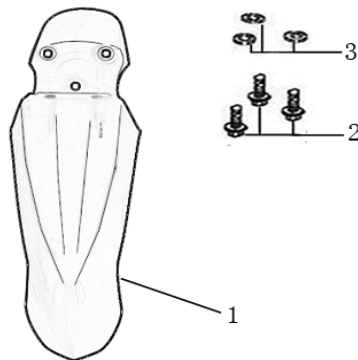







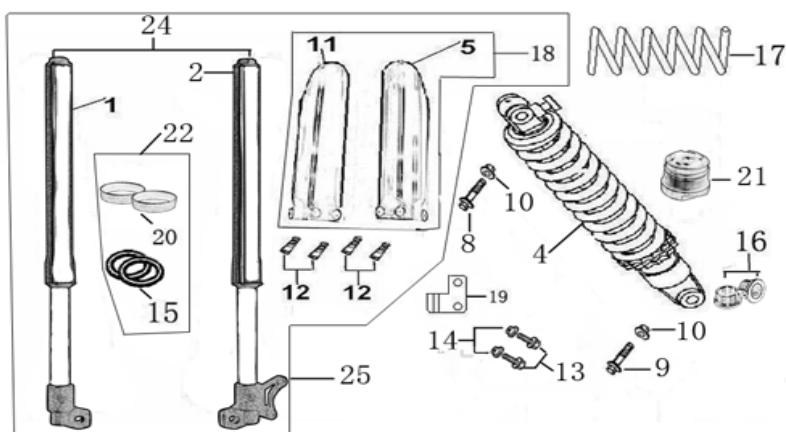





25	YC50-0227-02-GY	Complete Triple Clamp YCF50 135mm 2014 GREY	Te Fourche Complet YCF50 135mm 2014 GRIS	1	50A14-17	
26	YC50-0228	YCF50 Set of Bar mount not adjustable φ22.2 mm/bottom 35mm(with GB70-M8×20 8EA+GB93-Φ8 W 4EA)	Jeu pontet guidon YCF50 non ajustable φ 22.2 mm / pontet bas 35mm	1	50A12-17	
27	KRDIRECTION41-2	set of bearing for steering 41/24、 41/22.5	kit rlt colonne direction 41/24、 41/22.5	1	50A12-17/F88L17/F88s13-16/F88se1617/F125L1617/F150L17	
28	FB13-9×10×17-W	Front Number plate spacer (Top) φ 8.5×10×17	entretoise Plaque numero avant (Haut) φ 8.5×10×17	1	ALL BIKES2013/50A14-17/F88s14-16/F88se15-17/F88s1415/F125L16	
29	FB13-9×10×6-W	Front Number plate spacer (Bottom) φ 8.5×10×5.5	entretoise Plaque numero avant (Bas) φ 8.5×10×5.5	1	50A12-17/F88s12-16/F88se15-17	
30	YC110-0213-04	Number plate bracket long TOP BLACK	support plaque avant NOIR	1	50A13-17/F88s13-16/F88se15-17/F125L16	
31	GB5787-M6×10-W	Hex. Bolt M6X10	vis M6×10	1	50A12-17/F88s13-16/F88se1617	

Front Fender



N	Ref.	Description	Français	Qty/ Bike	MODEL	
1	YC50-031WH	Front Fender YCF50 RED	Gb avant YCF50 ROUGE	1	NEW 2018 50A18	
2	GB5787-M6×20-W	Hex. Bolt with flanged M6X20	vis M6X20	3	ALL BIKES	
3	GB96-Φ6-W	Washer φ6×φ18mm	Rondelle φ6×φ18mm	3	ALL BIKES	
3	YC110-03-01	Rubber washer Φ6×Φ18×4mm	caoutchouc Φ6×Φ18×4mm	3	ALL BIKES	
Front & Rear absorber						





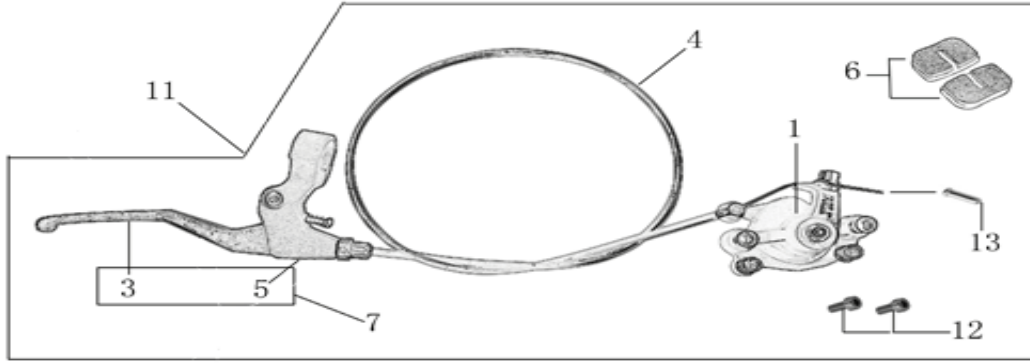

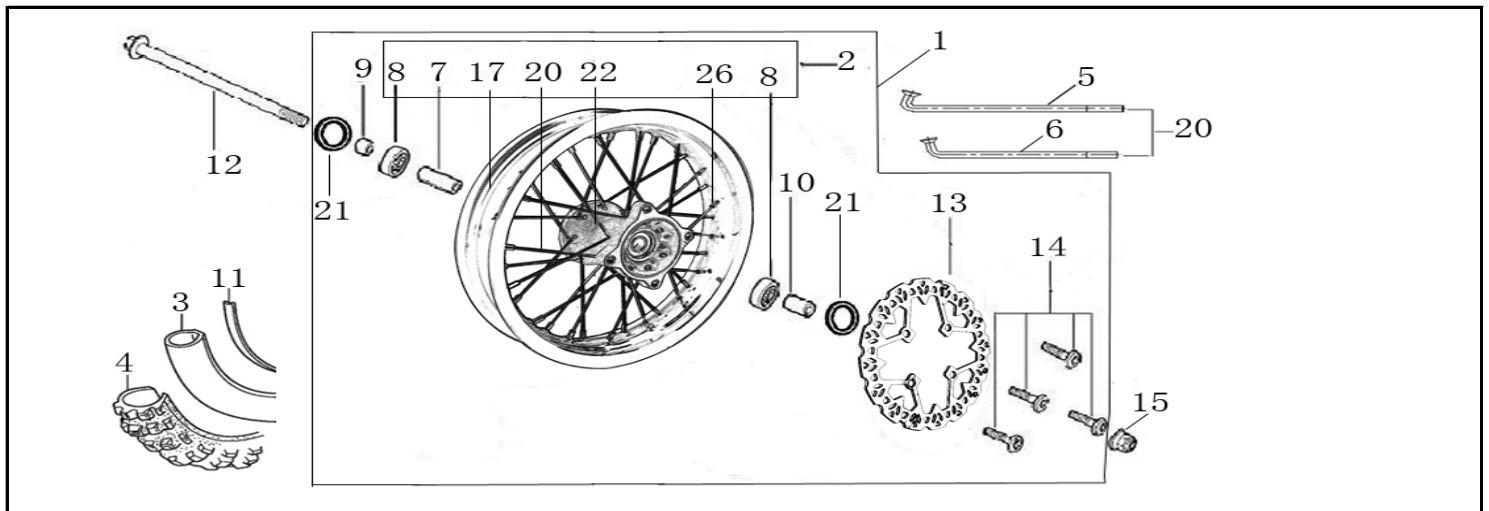

N	Ref.	Description	Français	Qty/ Bike	MODEL	
1	YC50-0401-04	Front right fork 530 mm (not adjustable) MAGNESIUM	tube fourche droit 530 mm MAGNESIUM	1	50A13-17	
2	YC50-0402-04	Front left fork 530mm (not adjustable) MAGNESIUM	tube fourche gauche 530 mm MAGNESIUM	1	50A13-17	
4	YC50-0404-03	YCF50 Shock absorber L=200mm 2014 YELLOW	Amortisseur YCF50 L=200mm 2014 JAUNE	1	50A14-17	
5	YC50-04-01-WH	Left front fork protection YCF50 L=530mm WHITE	Protection fourche gauche YCF50 L=530mm BLANC	1	50A12-17	
	YC50-0421-WH	YCF50 Brake Cable clip WHITE	Capot passe durite frein avant YCF50 BLANC	1	50A12-17	
	GB70-M4x15	Hex. Bolt M4x15	vis M4x15	2	50A12-17	
	GB6170-M4	Nut M4	ecrou M4	2	50A12-17	
8	GB5787-M10x45	Hex.bolt for shock absorber M10x45	Vis amortisseur M10x45	1	50A12-17	
9	GB5787-M10x45	Hex.bolt for shock absorber M10x45	Vis amortisseur M10x45	1	50A12-17	
10	GB6187-M10-W	Self-locking Nut M10	Ecrou vis amortisseur M10	2	50A12-17	
11	YC50-04-02-WH	Right front fork protection YCF50 L=530mm WHITE	Protection fourche droite YCF50 L=530mm BLANC	1	50A12-17	
12	GB70.2-M5x12	Plus screw M5X12	vis M5X12	4	50A12-17	
16	YC50-0410-02	shock top spacer 50CC 2014 Φ10×Φ22×21.5mm	Silent Block haut amortisseur 50CC 2014 Φ10×Φ22×21.5mm	1	50A14-17	
16	YC50-0411-03	shock bottom spacer 50CC 2014 Φ10×Φ20×Φ26×11mm	Silent Block bas amortisseur YCF50 Φ10×Φ20×Φ26×11mm	2	50A14-17	
18	YC50-0418WH	YCF50 set of fork protection WHITE	Jeu protection fourche YCF50 BLANC	1	50A12-17	
24	YC50-0400-03	YCF50 Pair of fork 530mm φ35 (not adjustable) MAGNESIUM	Jeu de fourche YCF50 530mm φ35 MAGNESIUM	1	50A13-17	
Front Brake Assy						



N	Ref.	Description	Français	Qty/ Bike	MODEL	
1	YC50-0502	YCF50 Front Brake caliper	Etrier frein avant YCF50	1	50A12-17/50E1617	
	YC50-0509	Rubber of Bolt $\Phi 3.5 \times 10$	Capuchin caoutchouc	1	50A17/50E17	
3	YC50-0501-02	Front Brake lever (right side) L=143MM	levier frein pour (levier droit) L=143MM	1	50A12-17	
	YC50-0515	Spring for front brake bracket M14x17	Ressort pour frein avant M14x17	1	50A12-17	
4	YC50-0501-03	YCF 50 Front brake cable 730mm. (with YC50-0513 1EA)	cable frein avant YCF50 730mm	1	50A12-17	
5	YC50-0501-01	YCF50 Rear (right side) brake bracket 2012	Cocotte frein arriere YCF50 (cote droit) 2012	1	50A12-17	
6	YC50-0506	YCF50 Front / Rear Brake pads	Jeu plaquette avant / arriere YCF50	2	50A12-17	
	YC50-0501	YCF50 Complete front brake assy	Levier frein avant complet avec cocotte YCF50	1	50A12-17	
11	YC50-0511	YCF50 front brake assy L=730mm	kit frein avant YCF50 L=730mm	1	50A12-17	
	YC50-0513	Brake cable caps 50CC	Embout Cables frein 50CC	1	50A12-17	
12	GB70-M6x25	Stud screw M6x25	vis M6x25	2	50A12-17	
Front Wheel Assy						









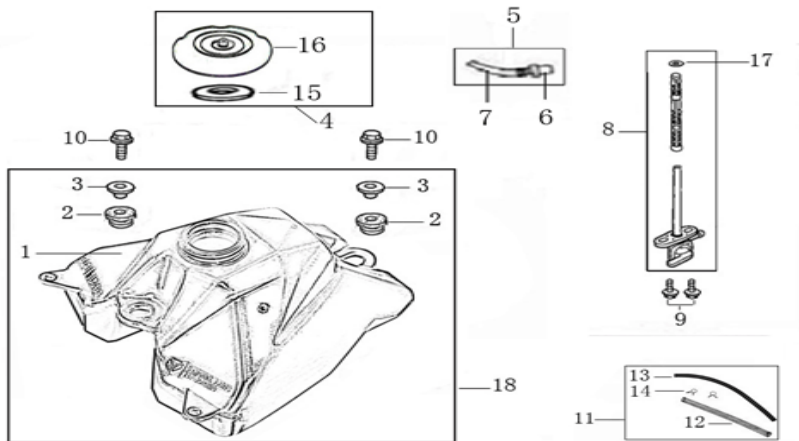







N	Ref.	Description	Français	Qty/ Bike	MODEL	
1	YC50-0601-04	YCF50 Front wheel complete STEEL10", with brake& hardware. Casting hub . But without tire	roue avant complète 10' YCF50 moyeux injectée cerceau acier avec disque sans pneu ni chambre ni fond jante	1	50A1617/50E17	
2	YC50-0602-01	STEEL front wheel 10' without disk	roue avant ACIER sans disque 10'	1	50A1617/50E17	
3	CHAMBRE10-2.5	Tube for front tire 2.50-10' GL	chambre air 2.50-10' GL	1	50A12-17/50E1617/F88s13-16/F88se15-17	
	FB6170-M8-Cr	Tire valve nut M8		1	ALL BIKES	
4	250/10	Tire 2.50-10' GUANGLI	pneu 250-10' GUANGLI	1	50A12-17/50E1617/F88s12-16/F88se1617/F88L17	
5	YC50-0605	outer spoke for 10wheel, 106 mm	Rayon extérieur 106 mm pour roue AV 10'	16	50A12-17/50E1617	
6	YC50-0622	inside spoke for 10wheel, 104mm	Rayon interieur 104 mm pour roue AV 10'	16	50A12-17/50E1617	
7	YC50-0607-01	Front axle bushing 50A $\Phi 14 \times \Phi 20 \times 46$	entretoise central roue avant 50A $\Phi 14 \times \Phi 20 \times 46$	1	50A12-17/50E1617	
8	6201RS	YCF50 Ball bearing 6201RS $\Phi 32 \times \Phi 12 \times 10$ mm	Roulement roue 6201RS $\Phi 32 \times \Phi 12 \times 10$ mm YCF50	2	50A12-17/50E1617	
9	YC50-06-052	YCF50 Right wheel spacer $\Phi 12 \times \Phi 22 \times 23$	entretoise roue avant droite $\Phi 12 \times \Phi 22 \times 23$ YCF50	1	50A12-17/50E1617	
10	YC50-06-051	Left wheel spacer $\Phi 12 \times \Phi 22 \times 26$	entretoise roue avant gauche $\Phi 12 \times \Phi 22 \times 26$	1	50A12-17/50E1617	
11	YC110-11-02	Tire lining for 10'	fond jante av 10'	1	50A12-17/50E1617/F88s12-16/F88se15-17/F88L17	
12	YC50-06-01	YCF50 Front Axle 170 mm with Self-locking nut $\Phi 12$	Axe de roue avant $\Phi 12$ L=170MM YCF50	1	50A12-17/50E1617	

13	YC50-0513-01	Front disk ϕ 160 mm 2016	disque frein avant ϕ 160mm 2016	1	50A1617/50E1617	
14	GB70.2-M6 \times 16	Socket head cap screw M6X16	vis disque frein M6X16	4	50A1617/50E1617	
15	GB6187-M12 \times P-W	Self-locking nut M12	écrou roue avant M12	1	50A1617/50E1617	
17	YC50-0617-01	STEEL Rim for Front wheel 1.4 \times 10'	cerceau roue av 1,4x10' ACIER	1	50A12-17/50E1617/F88s12-16/F88se15-17/F88L17	
20	JR10-10.6	set of spoke 10' 50cc 2012 (104mm \times 8+106mm \times 16+111mm \times 8)	JEUX RAYON AV 10' 50cc 2012 (104mm \times 8+106mm \times 16+111mm \times 8)	1	50A12-17/50E1617	
21	YC50-0610	OIL SEAL Φ 22 \times Φ 32 \times 5	joint spy roue Φ 22 \times Φ 32 \times 5	2	50A13-17/50E1617	
22	YC50-0622-02	YCF50 Front hub injected with washer	Moyeux avant injectée avec joint spy YCF50	1	50A12-17/50E1617	

Fuel Tank





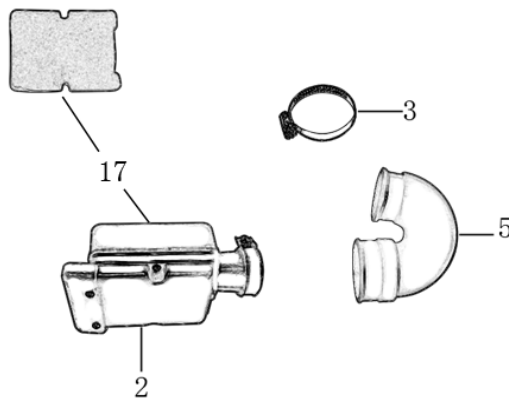

N	Ref.	Description	Français	Qty/ Bike	MODEL	
1	YC50-07012	YCF50 Fuel tank	Reservoir YCF 50cc	1	50A13-17	
2	YC110-07-01	Cushion for fuel tank	caoutchouc pour reservoir	2	ALL BIKES2011-17	
3	YC110-07-02	Washer for fuel tank Φ 12 \times Φ 30 \times 11mm	entretoise pour reservoir Φ 12 \times Φ 30 \times 11mm	2	ALL BIKES2011-17	
4	YC110-0702-01	YCF Tank cap plastic 2013	Bouchon reservoir plastique YCF 2013	1	ALL BIKES2013-17	
5	YC125-0704-BK	Fuel tank valve BLACK	Valve prise air NOIR	1	ALL BIKES	

6	YC110-0704-BK	Cap of Fuel tank valve BLACK	Capuchon Valve prise air NOIR	1	ALL BIKES	
7	YC110-0705-BK	Fuel tank valve Hose L=40mm BLACK	Durite caoutchouc Vale prise air L=40mm NOIRE	1	ALL BIKES	
8	YC110-0703	Fuel cock assy.	robinet essence	1	ALL BIKES	
9	GB5787-M6×16-W	Hex. Bolt with flanged M6X16	vis M6X16	2	ALL BIKES2012-2017	
10	GB5787-M8×25-B	Hex. Bolt with flanged M8X25 BLACK	vis M8X25 NOIR	2	50A13-17/F88s13-16/F88se15-17/F88L17/F125L1617/F150L17/F12513-16/F125s13-17/F125se15-17/SM125s13-17	
11	YC110-0706	fuel tank rubber line + spring Φ4.5×Φ8.5×210mm	durite reservoir avec ressort Φ4.5×Φ8.5×210mm	1	ALL BIKES	
12	YC110-07061	fuel tank Ispring L=180mm	ressort durite reservoir L=180mm	1	ALL BIKES	
13	YC110-07062	fuel tank rubber line Φ4.5×Φ8.5×210	durite reservoir Φ4.5×Φ8.5×210	1	ALL BIKES	
14	YC110-07063	Holding ring	collier FILTRE	2	ALL BIKES	
15	YC110-0720-02	Rubber mat for tank cap plastic Φ14×Φ52×2mm Oil proof	Caoutchouc bouchon reservoir YCF Φ14×Φ52×2mm	1	ALL BIKES2013-17	
17	YC50-0717	O-RING,Φ11×4mm For Fuel tank 50CC		1	50A13-17	
18	YC50-0718	YCF50 Complete fuel tank 2013 (with YC110-07-01 2EA+YC110-07-02 2EA)	Reservoir complet YCF50 2013	1	50A13-17	

Air Filter









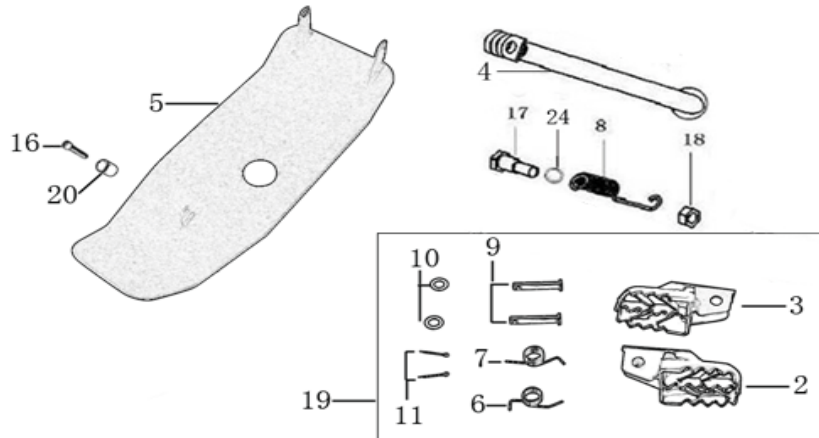









N	Ref.	Description	Français	Qty/ Bike	MODEL	
2	YC50-0801	Air box air filter assy Φ35	filtre air complet boite a air Φ35	1	50A12-17	
3	YC50-0803	Holding ring φ21-φ44mm	collier FILTRE φ21-φ44mm	1	50A12-17	

5	YC50-0805	YCF50 rubber connexion for air box	manchon boite air YCF50	1	50A12-17	
17	YC50-0802	YCF50 Air filter Foam	Mousse filtre a air YCF50	1	50A12-17	

Foot Peg assy









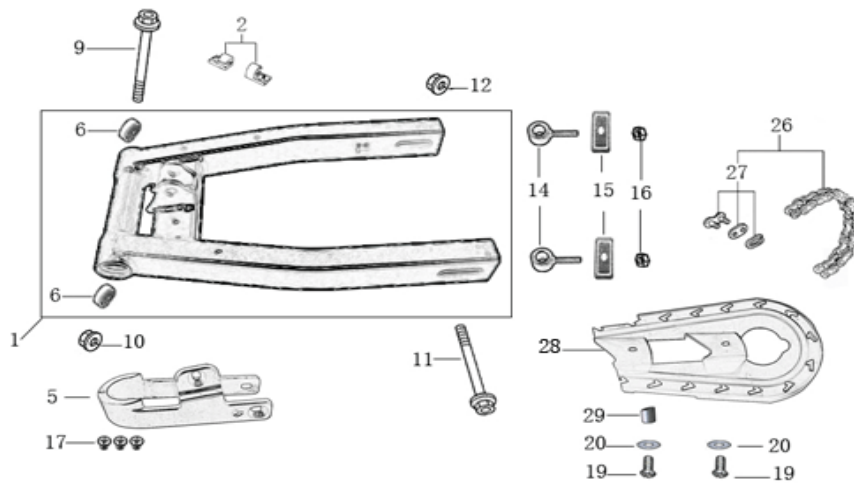











N	Ref.	Description	Français	Qty/ Bike	MODEL	
2	YC50-0902	YCF50 right foot pegs steel L=65mm GREY	Repose pied droit acier YCF50 L=65mm GRIS	1	50A12-17/50E1617	
3	YC50-0901	YCF50 left foot pegs steel L=65mm GREY	Repose pied gauche acier YCF50 L=65mm GRIS	1	50A12-17/50E1617	
4	YC50-190	Kick stand 190mm	bequille 190mm	1	50A12-17/50E1617	
5	YC50-204-01	YCF50 Engine skid plate steel T=2mm MATTE BLACK	sabot acier YCF50 T=2mm NOIR MAT	1	50A13-17	
	FB13-9×10×10-W	bushing skid plate Φ8.5×Φ10×10mm	entretoise Bras acier Φ8.5×Φ10×10mm	1	50A13-17	
6	YC110-09-01	Spring for right steel foot peg Φ1.5×Φ16.5×10mm	ressort repose pied droit acier Φ1.5×Φ16.5×10mm	1	ALL BIKES2013-2017(BUTSP/BIGYF150MX/FD190MX)	
7	YC110-09-02	Spring for left steel foot peg Φ1.5×Φ16.5×10mm	ressort repose pied gauche acier Φ1.5×Φ16.5×10mm	1	ALL BIKES2013-2017(BUTSP/BIGYF150MX/FD190MX)	
8	YC110-19-01	spring for kick stand Φ2.5×Φ15×105	ressort bequille Φ2.5×Φ15×105	1	ALL BIKES2014-17(BUTSP1/SP2/SP3)	
9	GB882-Φ8×43-W	shaft pin for steel footpegs φ8×43	axe repose pied acier φ8×43	2	ALL BIKES2014-17(BUT50A/50E/SP1/SP2/SP3)	
10	GB97-Φ8-W	flat washer φ8×16×1	rondelle φ8×16×1	2	ALL BIKES2011-17	
11	GB91-Φ2×25-W	Cotter pin 2.0×25	goupille 2.0×25	2	ALL BIKES2013-17	

16	GB70-M8×20-W	Hex. Bolt M8×20	vis boucle arriere M8×20	1	50A14-17	
17	FB02-M10×1.5×30I	Stepped screw M10X35 for kick stand	vis bequille M10X35	1	ALL BIKES2014-17(BUTSP1/SP2/SP3)	
18	GB6170-M10-G	Hex. Nut M10	ecrou bequille M10	1	ALL BIKES2014-17(BUTSP1/SP2/SP3)	
19	YC50-0902/03	Steel set of foot pegs 50cc Grey	jeu repose pied acier 50cc Grise	1	50A12-17/50E1617	
24	GB93-Φ10-W	Standard spring washer φ10	rondelle φ10	1	ALL BIKES2014-17(BUTSP1/SP2/SP3)	

Swing Arm assy



N	Ref.	Description	Français	Qty/ Bike	MODEL	
1	YC50-10014	YCF50 Mono swing arm BLACK	bras oscillant mono YCF50 NOIR	1	50A12-17	
2	YC110-10-014-BK	Rear brake clip for BLACK	attache durite frein arriere NOIR	1	ALL BIKES2012-15(BUTSP1/SP2/SP3)/ ALL BIKES2016-17 (BUTSP2/SP3)	
5	YC50-10-01	YCF Chain slider 50cc	patin chaine YCF 50cc	1	50A12-17	
6	6001/28-12-08	Swing arm bearing φ28xφ12x8mm	roulement bras oscillant φ28xφ12x8mm	2	ALL BIKES2009-17	
9	YC50-1009	Swing arm shaft with self lock nut φ12X190mm	axe bras oscillant φ12×190mm	1	50A12-17	
10	GB6187-M12-W	Self locking nut M12	ecrou bras oscillant M12	1	ALL BIKES2012-2017(BUT50A)	
11	YC50-11-02	YCF50 Rear wheel axle M12x215 with Self locking nut M12	axe roue arriere YCF50 L=215mm avec ecrou φ12	1	50A13-17	

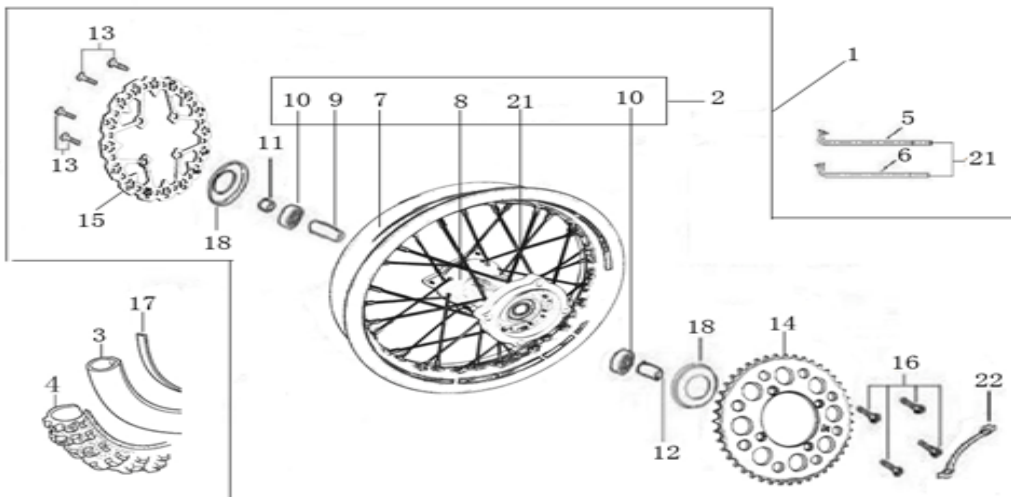

16	YC50-1001-001	YCF50 Block axle	Tendeur chaine YCF50	2	50A12-17	
16	YC50-1001-002	YCF50 Block axle fixing plate	Patte acier fixation tendeur chaine YCF50	2	50A12-17/LITE 2017	
	GB6189-M8-W	Cltch Self-lock Nut M8	ecrou M8	2	50A12-17	
17	GB819-M6x16-W	Plus screw M6X16	vis m6x16	5	ALL BIKES2015-17(BUTSP2/SP3/BIGYF150MX/FD190MX)	
	GB6100-M6-CW	nut M6x25mm	Vis M6x25mm	5	ALL BIKES2015-17(BUTSP2/SP3/BIGYF150MX/FD190MX)	
19	GB818-M6x16-W	Plus screw M6x16	vis M6x16	1	50A12-17	
19	GB818-M6x25-W	Plus screw M6x25	vis M6x25	1	50A12-17	
20	GB97-Φ6	Flat washer φ6	rondelle φ6	3	ALL BIKES2012-17	
26	420H-84	YCF50 Driving chain 420H-84T	Chaîne 420 84 maillons YCF50	1	50A1617	
27	AR-420	Chain link	Attache rapide chaine	1	All BIKES2012-17(BUT50E)	
28	YC50-0600-01	YCF50 Chain box protection YCF50	Protection chaine plastique YCF50	1	50A12-17	
	FB13-6x12x12	bushing Φ6xΦ12x12	entretoise Φ6xΦ12x12	1	50A12-17	

Rear Wheel Assy









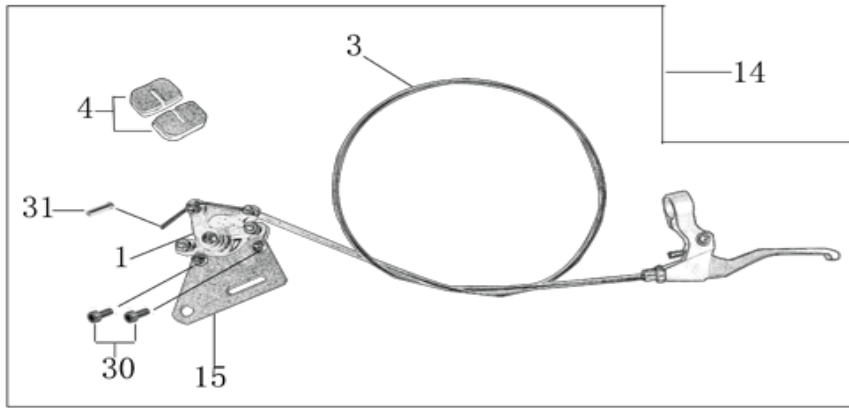

N	Ref.	Description	Français	Qty/ Bike	MODEL	
1	YC50-1101-04	YCF50 Complete STEEL Rear wheel 1.40-10' Casting hub with disk 2016	roue arriere complète YCF50 Acier 1.40-10' moyeux injecte avec disque	1	50A1617/50E1617	

2	YC50-1102-01	Complete STEEL Rear wheel 1.40x10' without disk	roue arriere complete ACIER 1.40x10' moyeux injecte sans disque	1	50A1617/50E1617	
3	CHAMBRE10-2.5	Tube for Rear tire 2.50-10 GL	chambre air 2.50-10' GL	1	50A12-17/50E1617/F88s13-16/F88se15-17	
	FB6170-M8-Cr	Tire valve nut M8		1	ALL BIKES	
4	250/10	YCF tyre 2.50/10' GUANGLI	pneu 2.50/10' YCF GUANGLI	1	50A12-17/50E1617/F88s13-16/F88se15-17	
5	YC50-0606	outer spoke for 10' wheel 108 mm	Rayon extérieur 108 mm pour roue AV 10'	16	50A12-17/50E1617	
6	YC50-0605	inside spoke for 10' wheel 106 mm	Rayon interieur 106 mm pour roue AV 10'	16	50A12-17/50E1617	
7	YC50-1117-01	STEEL Rim 1.40x10'	cerceau roue 1,40x10 ACIER	1	50A12-17/50E1617/F88s12-16/F88se15-17/P88s12-15	
8	YC50-1122-02	YCF50 Rear wheel hub Casting with seal	Moyeux arriere YCF50 injecte avec joint spy	1	50A1617/50E1617	
10	6201RS	Ball bearing 6201RS Φ32×Φ12×10mm	roulement roue 6201RS Φ32×Φ12×10mm	2	50A12-17/50E1617	
12	YC50-11-041	Axle spacer,Φ22×Φ12×25mm (left/right)	entretoise roue arriere (droit/gauche) Φ22×Φ12×25mm	2	50A14-17/50E1617	
13	GB70.2-M6×16	Socket head cap screw M6×16	vis de disque M6×16	4	50A12-17/50E1617	
14	YC110-11-06/45	YCF Driven sprocket 420-45T	couronne acier 45T YCF	1	50A1617/F125L1617/F150L17/F12512-16/F125s12-17/F125se15-17/P12513-17/P15013-17/SM12-17	
15	YC50-0513-01	YCF50 disk φ160 mm 2016	disque YCF50 φ160mm 2016	1	50A1617/50E1617	
16	GB5783-M8×20-W	Exterior Hex.Bolt M8X20	vis couronne m8x20	4	50A12-17/50E1617	
17	YC110-11-02	Tire lining for 10'	fond jante 10'	1	50A12-17/50E1617/F88s12-16/F88se15-17/F88L17	
18	YC50-0610	OIL SEAL Φ22xΦ32x5	joint spy roue Φ22xΦ32x5	2	50A13-17	

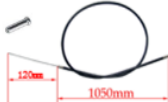
21	JR10-10.5	set of spoke 10' (106mm×16+111mm×16)	jeu rayon arrière 10' (106mm×16+111mm×16)	1	50A12-17/50E1617/F88s12-16/F88se15-17/F88L17/P88s13-15	
22	YC110-11-03	Sprocket Locking piece	block couronne	2	ALL BIKES2013-17 (BUTSP1/SP2/SP3/BIGY)	

REAR BRAKE



N	Ref.	Description	Français	Qty/ Bike	MODEL	
1	YC50-1201	YCF50 Rear Brake caliper	Etrier frein arriere YCF50	1	50A12-17/50E1617	
	YC50-0509	Rubber of Bolt $\Phi 3.5 \times 10$		1	50A17/50E17	
3	YC50-0502-03	YCF50 Rear brake steel line 1050mm A+B=120mm (with YC50-0513 1EA)	durite frein arriere YCF50 1050mm A+B=120mm	1	50A12-17/50E1617	
4	YC50-0506	Front / Rear Brake pads	jeu plaquette avant / arriere	2	50A12-17/50E1617	
14	YC50-1214	YCF50 Rear brake assy L=1050mm	Kit frein arriere YCF50 L=1050mm	1	50A12-17/50E1617	
	YC50-0513	Brake cable caps 50CC	Embout Cables frein 50CC	1	50A12-17/50E1617	
15	YC50-120101-02	Rear brake bracket T=3mm 2014	patte fixation étrier frein arriere T=3mm 2014	1	50A12-17/50E1617	
	FB13-7×10×4-W	bushing $\Phi 7 \times \Phi 10 \times 4$ mm	entretoise $\Phi 7 \times \Phi 10 \times 4$ mm	2	50A14-17/50E1617	
30	GB70-M6×12	Hex. Bolt M6×12	vis M6×12	2	50A12-17/50E1617	

Exhaust system

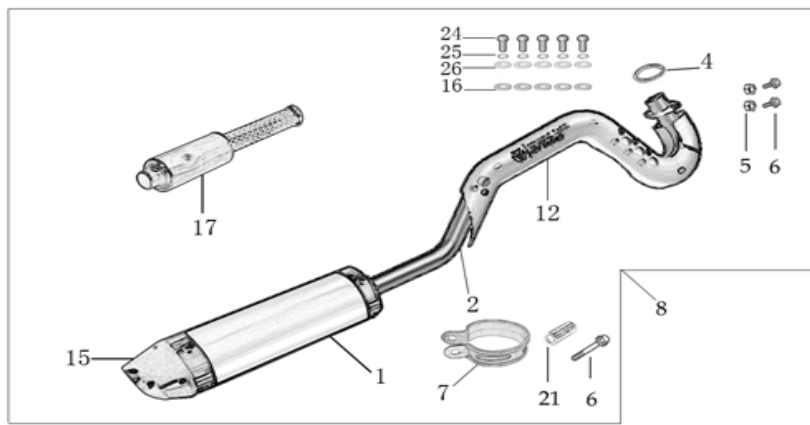







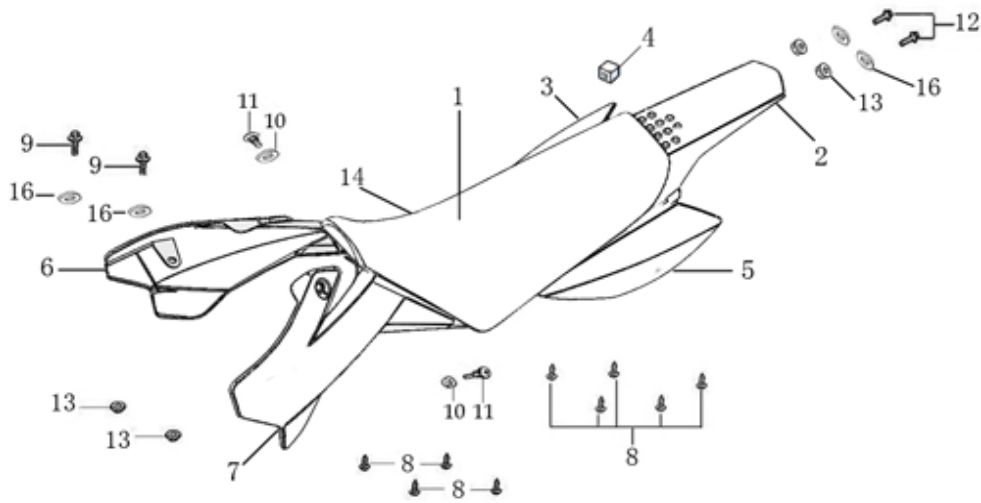









N	Ref.	Description	Français	Qty/ Bike	MODEL	
1	YC50-13016-GY	YCF50 Muffler L=240mm 2015 GREY	Silencieux YCF50 2015 GREY	1	50A15-17	
2	YC50-13010-02	Exhaust pipe Φ22mm 2014	collecteur Φ22mm 2014	1	50A14-17	
4	YC50-1304	Exhaust pipe washer φ21×φ15×4mm	joint pot φ21×φ15×4mm	1	50A12-17	
5	GB6170-M6-W	Hex flanged self locking nut M6	écrou M6	2	ALL BIKES	
6	GB5787-M8×35-W	Hex. Bolt with flanged M8×35	vis M8×35	1	50A13-17/P12513-17/P15013-17/SM15013-17	
7	YC50-13-01	Hoop for muffler YCF50 (with FB13-Φ10×Φ14×10-W 1EA+GB5787-M8×35-W 1EA)	Attache silencieux YCF50	1	50A12-17	
8	YC50-132-02-GY	YCF50 Muffler& Exhaust pipe assy 2015 GREY	Echappement complet YCF50 2015 GRISE	1	50A15-17	
12	YC50-1312-01	YCF50 protection for exhaust pipe 2014 (3PCS)	Grille pot YCF50 2014	1	50A14-17	
15	YC50-13-33	YCF50 Muffler end cap YCF	Embout silencieux YCF50	1	50A12-17	
16	YC50-1316	exhaust pipe heat spacer 50CC Φ6×Φ12×1.5mm	Joint embout silencieux 50CC Φ6×Φ12×1.5mm	5	50A12-17	
17	YC50-13-30	YCF50 Noise reducer (spark arrestor)	Bride de pot YCF50	1	50A12-17	
21	FB13-10×14×10-W	Muffler Hoop spacer Φ10×Φ14×10mm	Entretoise attache silencieux Φ10×Φ14×10mm	1	50A13-17/P12513-15/P15013-15/SM15013-15	
24	GB70.2-M6×10-Cr	Plus screw M6×10	vis M6×10	3	ALL BIKES 2012-17	
25	GB93-Φ6-W	Standard spring washer φ6	rondelle φ6	3	ALL BIKES 2012-17	

26	GB97-Φ6-W	flat washer φ6	rondelle φ6	3	ALL BIKES 2012-17	
----	-----------	----------------	-------------	---	-------------------	-------------------------------------------------------------------------------------

Seat & Plastic kit









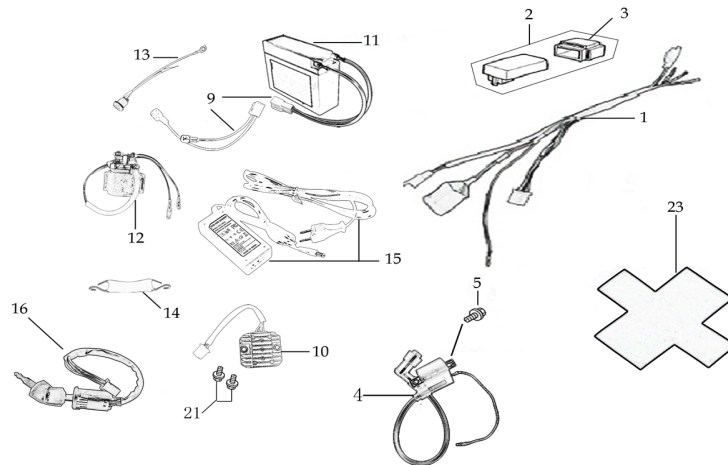









N	Ref.	Description	Français	Qty/ Bike	MODEL	
1	YC50-1401-05	YCF50 Seat assy L=405mm 2016	Selle YCF50 2016	1	50A1617/50E1617	
2	YC50-14-012-WH	YCF50 Rear fender WHITE	Garde boue arrière YCF50 BLANC	1	5012/50A15-17/50E17	
3	YC50-14-022-WH	YCF right side plastic WHITE	Plaque latérale droite YCF BLANCHE	1	50A12-17/50E17	
4	YC110-14-03	Cushion for right side plastic	caoutchouc plaque laterale droite	1	ALL BIKES	
5	YC50-14-042-WH	YCF50 Left side plastic WHITE	Plaque latérale gauche YCF50 BLANCHE	1	50A12-17/50E17	
6	YC50-14-05-WH	YCF Right shroud WHITE 50CC	ouie radiateur droite YCF 50CC BLANC	1	5012/50A17/50E17	
7	YC50-14-06-WH	YCF50 Right shroud WHITE	Ouie radiateur droite YCF50 BLANCHE	1	5012/50A17/50E17	
8	GB845-ST4.8x16-G	Screw for plastic kit ST4.8x16	vis plastique ST4.8x16	9	ALL BIKES2012-17(BUT BIGY)	
9	GB5787-M6x20-W	hex. Bolt with flanged M6x20	vis M6x20	2	ALL BIKES	
10	YC110-02-13	Rubber washer Φ6×Φ14×3mm	joint caoutchouc Φ6×Φ14×3mm	2	ALL BIKES2012-17	
11	FB5787-M5x12-W	hex. Bolt with flanged M5x12	vis M5x12	2	ALL BIKES2012-17	
11	GB96-Φ5-W	flat washer Φ5×Φ12	rondelle Φ5×Φ12	2	ALL BIKES2015-17	

12	GB5787-M6×20-B	hex. Bolt with flanged M6x20 BLACK	vis M6x20 NOIR	2	ALL BIKES2015-17	
13	GB6177-M6-W	Hex. Flanged nut M6	écrou M6	2	ALL BIKES2015-17	
16	YC110-03-01	Rubber washer Φ6×Φ18×4mm	joint caoutchouc Φ6×Φ18×4mm	4	ALL BIKES2015-17	
16	GB96-Φ6	flat washer φ6	rondelle φ6	4	ALL BIKES2015-17	

ELECTRIC









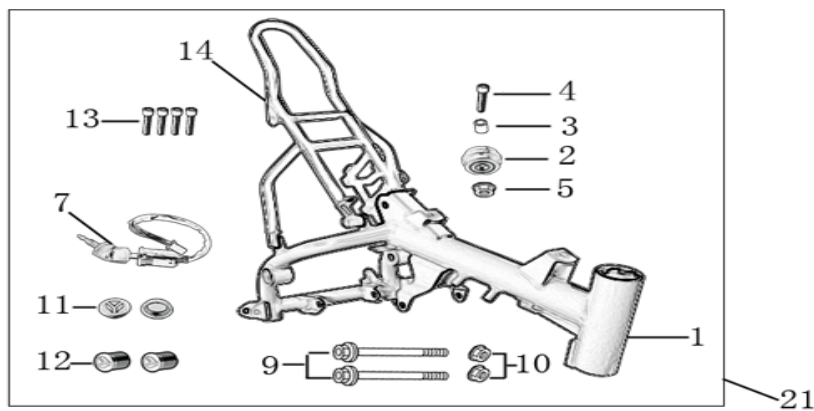





N	Ref.	Description	Français	Qty/ Bike	MODEL	
1	YC50-1501-01	Wire harness 50CC 2014	Faisceaux électrique 50CC 2014	1	50A14-17	
	YC50-1547-01	Fuse 50A Φ6×30mm F15AL250V		1	50A14-17	
2	YC50-1503	CDI Ignitor assy.50A	CDI 50A	1	50A12-17	
3	YC50-1509	Ignitor rubber small	caoutchouc cdi	1	50A12-17	
4	YC50-1504	Ignitor coil L=130mm	bobine haute tension L=130mm	1	50A12-17	
5	GB5787-M6×16-W	Hex. Bolt M6x16	vis m6x16	2	ALL BIKES2012-2017	
9	YC50-1515	Battery cable RED	Cable pour Chargeur Batterie ROUGE	1	50A13-17	
9	YC50-1516	Battery cable BLACK	Cable pour Chargeur Batterie NOIR	1	50A13-17	
10	YC50-1502	rectifier for 50CC	Rectificateur	1	50A12-17	

11	YC50-1507-01	Battery 12V 2.3AH BT4B-BS 50CC 2015	Batterie 12V 2.3AH BT4B-BS 50CC 2015	1	50A14-17	
12	YC50-1510	relay 50CC	Relais demarreur 50CC	1	50A12-17/F88se15-17/F125se15-17	
13	YC50-1513	Charger connexion 50CC	Connection chargeur 50CC	1	50A13-17	
	YC110-1515-01	Charger connexion protection rubber cap	Caoutchouc protection prise chargeur		50A18/START F88SE-18/START F125SE-18	
14	YC110-1508-01	Hustle rubber 2016	Maintien complet Batterie 2016	1	50A17/F88se1617/F125se1617	
16	YC110-0021-02	Key contactor Waterproof 2018	Contacteur a cle 2018	1	NEW 2018 50A18/50E18/F88se18/F125se18	
21	GB5787-M6x10-W	Hex. Bolt M6x10	vis M6x10	2	50A12-17/F88s13-16/F88se1617	
23	YC50-1523-01	Battery protection 50A 117x45x87mm	Protection Batterie 50A 117x45x87mm	1	50A15-17	

Frame









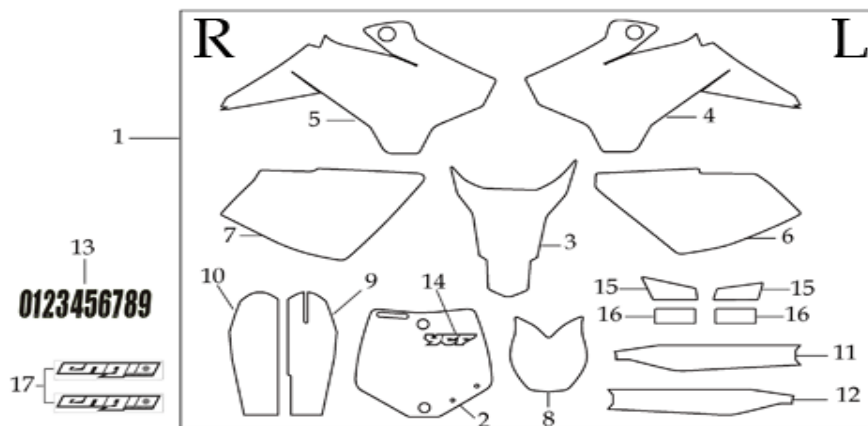





N	Ref.	Description	Français	Qty/ Bike	MODEL	
1	YC50-172-01-WH	YCF50 Frame 2014 WHITE +2°	Cadre YCF50 2014 BLANC + 2°	1	50A14-17	
2	YC50-2201	YCF Chain tensioner component	roulette chaine YCF	1	50A12-17	
	YC50-2201-01	bushing $\Phi 10 \times \Phi 14 \times 10$ mm	entretoise $\Phi 10 \times \Phi 14 \times 10$ mm	1	50A12-17	
	GB70-M10x50x1.5W	Hex. Bolt M10x50	Vis M10x50	1	50A12-17	
	GB6187-M10-1.5-W	Self-locking Nut M10	écrou M10	1	50A12-17	

9	GB5787-M8x95-W	Hex. Bolt with flanger M8x95	vis M8x95	2	50A13-17	
10	GB6187-M8-W	Self locking nut M8	ecrou M8	2	ALL BIKES	
11	YC50-1210	Rubber cover (swing arm axle)	Capuchon cadre (axe bras)	2	50A12-17	
11	YC50-1211	Rubber cover (bottom of frame) 50CC	Capuchon cadre (dessous cadre) 50CC	2	50A12-17	
12	GB70-M8x16	Hex. Bolt M8X16	vis M8x16	4	50A12-17	
14	YC50-16-02-BK	YCF50 Rear frame part Chromolly 2014 BLACK	Boucle arriere YCF50 Chromolly 2014 NOIRE	1	50A14-17	
21	YC50-1621-01-WH	complète frame YCF50 2014 WHITE (with YC50-1211 2EA)	cadre complet YCF50 2014 BLANC	1	50A14-17	



GRAPHICS

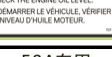
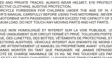

N	Ref.	Description	Français	Qty/ Bike	MODEL	
1	KD50A2018	YCF50 complete graphic kit 2018	Kit deco complet YCF50 2018	1	NEW 2018 50A18	
2	YC50-2502-01	YCF50 Front plate graphic 2018	Sticker Plaque avant YCF50 2018	1	50A18	
3	YC50-2503-01	YCF50 Rear mudguard graphic 2018	Sticker GB Arriere YCF50 2017	1	50A18	
4	YC50-2504-01	YCF50 Left shrouder graphic 2018	Sticker Ouie gauche radiateur YCF50 2018	1	50A18	
5	YC50-2505-01	YCF50 Right shrouder graphic 2018	Sticker Ouie droite radiateur YCF50 2018	1	50A18	

6	YC50-2506-01	YCF50 Left side plate graphic 2018	Sticker Plaque laterales gauche YCF50 2018	1	50A18	
7	YC50-2507-01	YCF50 Right side plate graphic 2018	Sticker Plaque laterales droite YCF50 2018	1	50A18	
8	YC50-2508-01	YCF50 front fender Front fender graphic 2018	Sticker GB Avant YCF50 2018	1	50A18	
9	YC50-2509-01	YCF50 Front left shock protection graphic 2018	Sticker Protection fourche gauche YCF50 2018	1	50A18	
10	YC50-2510-01	YCF50 Front right shock protection graphic 2018	Sticker Protection fourche droit YCF50 2018	1	50A18	
16	KDMINE-01-BK	Minerva Sticker left 2017 BLACK	Sticker Minerva gauche 2017 NOIR	1	50A17/50E17/F88se17/F125s17/F125se17	
16	KDMINE-02-BK	Minerva Sticker right 2017 BLACK	Sticker Minerva droit 2017 NOIR	1	50A17/50E17/F88se17/F125s17/F125se17	
	YC110-1901	Sticker Chain	Autocollant Chaîne	1	ALL BIKES2013-17	
	YC110-1902	Sticker Tire	Autocollant Pression Pneu	1	ALL BIKES2013-17	
	YC110-1903	Sticker Warning OIL Level	Autocollant Attention Niveau Huile	1	ALL BIKES2013-17	
	YC50-1904	Sticker Rear Mudguard 50A 70x57mm	Autocollant garde boue arriere 50A 70x57mm	1	50A1617/	
	YC50-1904-01	Sticker Rear Mudguard 50A Charging 65x34mm		1	50A1617/F88se1617/F125se1617	
	YC110-1905	Sticker CE	Autocollant CE	1	ALL BIKES2013-17	
	YC110-1906	Warning sticker	Sticker Attention	1	ALL BIKES2013-17	
	YC110-1907	Warning Sticker Transport	Sticker Caisse Avertissement Transport	1	ALL BIKES2013-17	
	YC110-1908	Warning Sticker Shosk Absorber	Sticker Avertissement Amortisseur	1	ALL BIKES2013-17	
ENGINES						
	MOTEUR50-01-GY	Engine 50cc 2013	Moteur 50cc 2013	1	50A13-17	

	17311-1	Inlet Pipe,Pro 50cc 2012	PIPE ADMISSION 50cc 2012	1	50A13-17	
	YC50-20-29	carburettor paper gasket	joint papier carburateur	1	50A13-17	
	YC50-20-25	intake pipe paper gasket	joint papier admission	1	50A13-17	
	YC50-20-26	intake pipe isolating gasket	joint plastique admission	1	50A13-17	
	YC50-20-93-GY	magneto crankcase 50CC 2013 GREY	carter d'allumage GRISE	1	50A13-17	
	YC50-20-87-GY	right crankcase cover GREY	carter moteur gauche GRISE	1	50A13-17	
	YC50-20-97	sprocket cover	protection PSB	1	50A13-17	
	420H/10T	Sprocket(10T)	PSB 10 DTS	1	50A13-17	
CARBU						
	YC50-20-31	Carburetor 5012 with main jet 50	Carburateur 5012 GICLEUR 50	1	50A13-16	
	GICLEUR50	main jet 50	GICLEUR 50	1	50A13-16	
CARTONS - CAISSES MOTOS						
	YC110-CARTON-50	BIKE BOX 50 YCF 1280×380×840mm	CARTON EMBALLAGE MOTO 50	1	50A12-17	
	YC110-FOAMBOX	Foam box 2014 420×340×160mm	Cale PS	1	ALL BKIES2014-17	
	YC110-FILM	Protective film for seat 600×600×0.02mm	Protection plastique Selle	1	ALL BKIES2014-17	
CATALOGUES - FICHES MOTOS - FICHES STICKER						
	YC110-0700-01	Accessory tools	Trousse a outils	1	ALL BIKES2013-17	

	YC110-0700-0201	Owner manual 2015	Manuel Utilisation 2015	1	ALL BIKES2013-17	
	YC110-0700-0401	Vin Plate 2015	Plaque Vin 2015	1	ALL BIKES2013-17	
	YC110-0700-03	A4 sheet assy	Fiche A4	1	ALL BIKES2013-17	